

γ -ray spectroscopy

- ❖ γ -decay is an *electromagnetic process* where the nucleus decreases in excitation energy, but does not change proton or neutron numbers
- ❖ This decay process only involves the emission of photons (γ -rays carry spin 1)

mass →	$\approx 2.3 \text{ MeV}/c^2$	$\approx 1.275 \text{ GeV}/c^2$	$\approx 173.07 \text{ GeV}/c^2$	0	$\approx 126 \text{ GeV}/c^2$
charge →	$2/3$	$2/3$	$2/3$	0	0
spin →	$1/2$	$1/2$	$1/2$	1	0
	u up	c charm	t top	g gluon	H Higgs boson
QUARKS					
	$\approx 4.8 \text{ MeV}/c^2$	$\approx 95 \text{ MeV}/c^2$	$\approx 4.18 \text{ GeV}/c^2$	0	
	$-1/3$	$-1/3$	$-1/3$	0	
	$1/2$	$1/2$	$1/2$	1	
	d down	s strange	b bottom	γ photon	
	$0.511 \text{ MeV}/c^2$	$105.7 \text{ MeV}/c^2$	$1.777 \text{ GeV}/c^2$	$91.2 \text{ GeV}/c^2$	
	-1	-1	-1	0	
	$1/2$	$1/2$	$1/2$	1	
	e electron	μ muon	τ tau	Z Z boson	
LEPTONS					
	$< 2.2 \text{ eV}/c^2$	$< 0.17 \text{ MeV}/c^2$	$\approx 15.5 \text{ MeV}/c^2$	$80.4 \text{ GeV}/c^2$	
	0	0	0	± 1	
	$1/2$	$1/2$	$1/2$	1	
	ν_e electron neutrino	ν_μ muon neutrino	ν_τ tau neutrino	W W boson	
					GAUGE BOSONS

- ❖ Basic γ -ray properties, observables
- ❖ γ -ray interactions in matter
- ❖ Detector types
- ❖ Measurement techniques

THE ELECTROMAGNETIC SPECTRUM

Penetrates Earth Atmosphere?



Wavelength (meters)



About the size of...

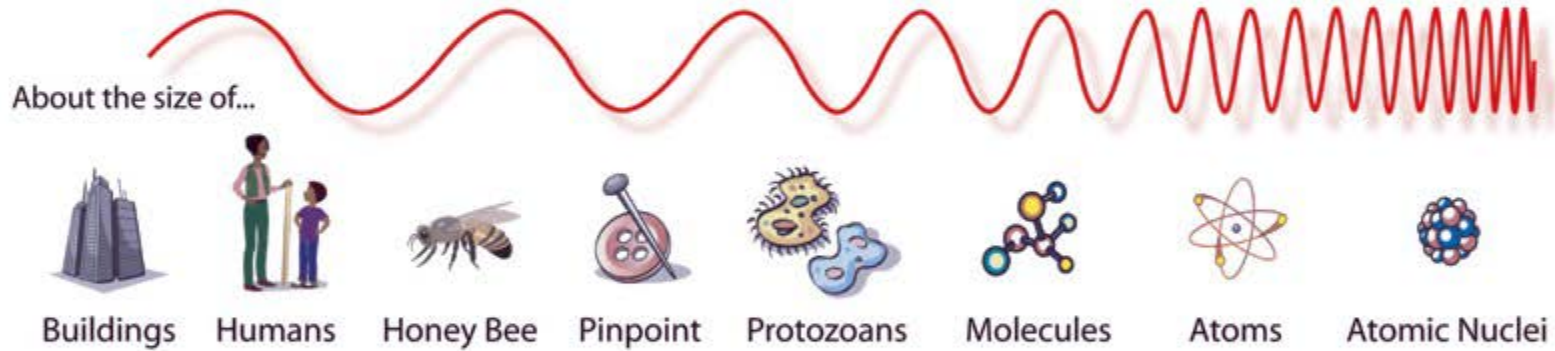

Frequency (Hz)

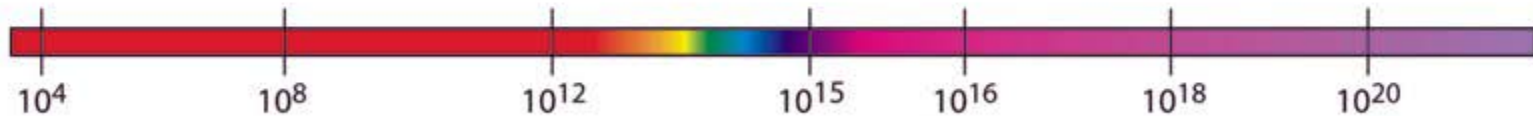

Temperature of bodies emitting the wavelength (K)

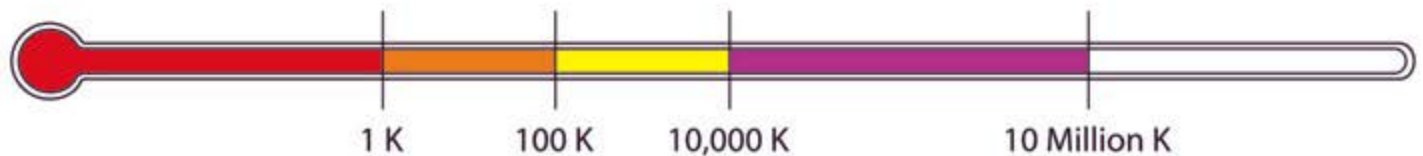

γ -decay

❖ Gamma-ray emission is usually the dominant decay mode

Measurements of γ -rays let us deduce:

Energy, Spin (angular distr. / correl.), Parity (polarization), magnetic moment, lifetime (recoil distance, Doppler shift), ... of the involved nuclear levels.

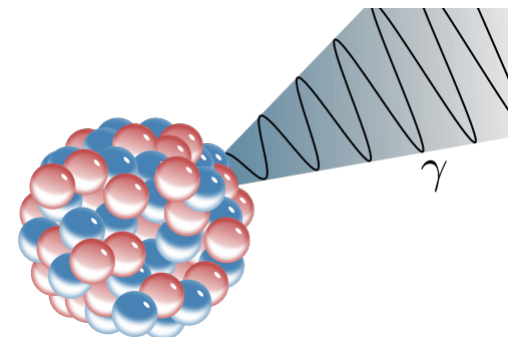

^{137}Cs detected in **red**: NaI scintillator

blue: HPGe (high purity Ge semiconductor)

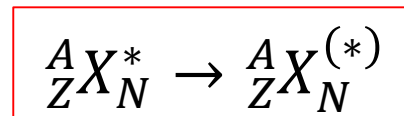
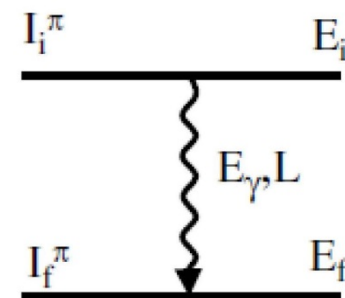
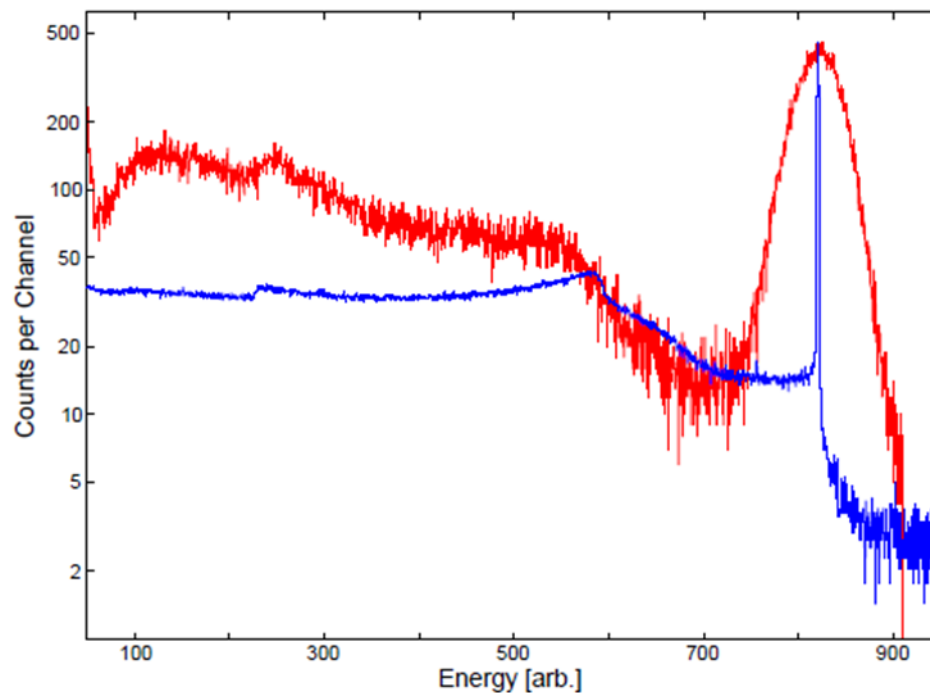

γ -decay in a Nutshell

- ❖ The photon emission of the nucleus essentially results from a re-ordering of nucleons within the shells.
- ❖ This re-ordering often follows α or β decay, and moves the system into a more energetically favorable state.

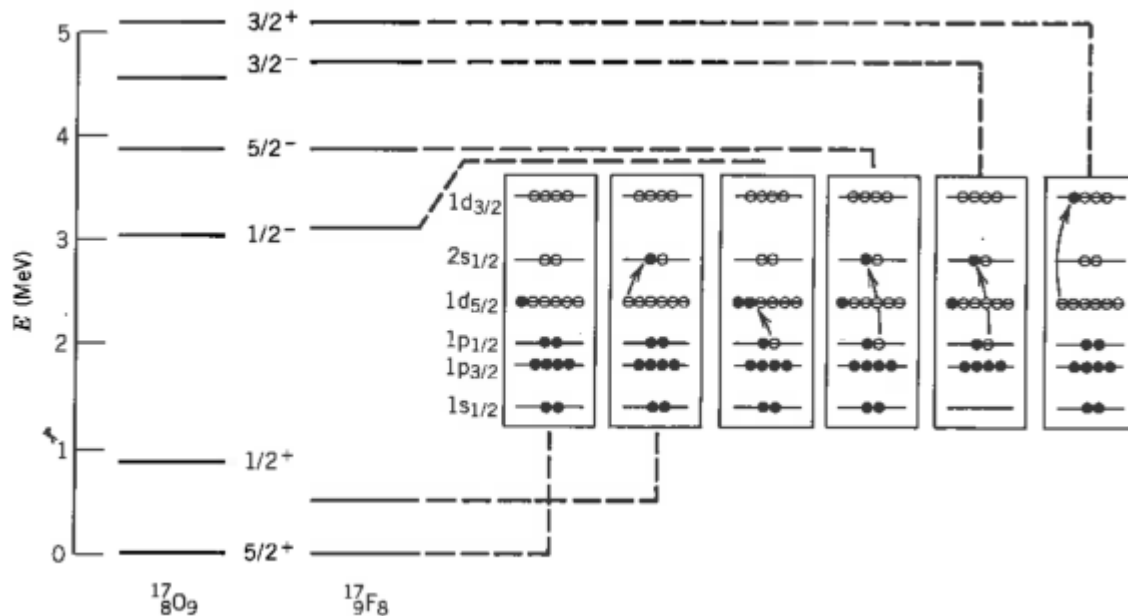

Source: Krane, Fig. 5.11

γ -decay

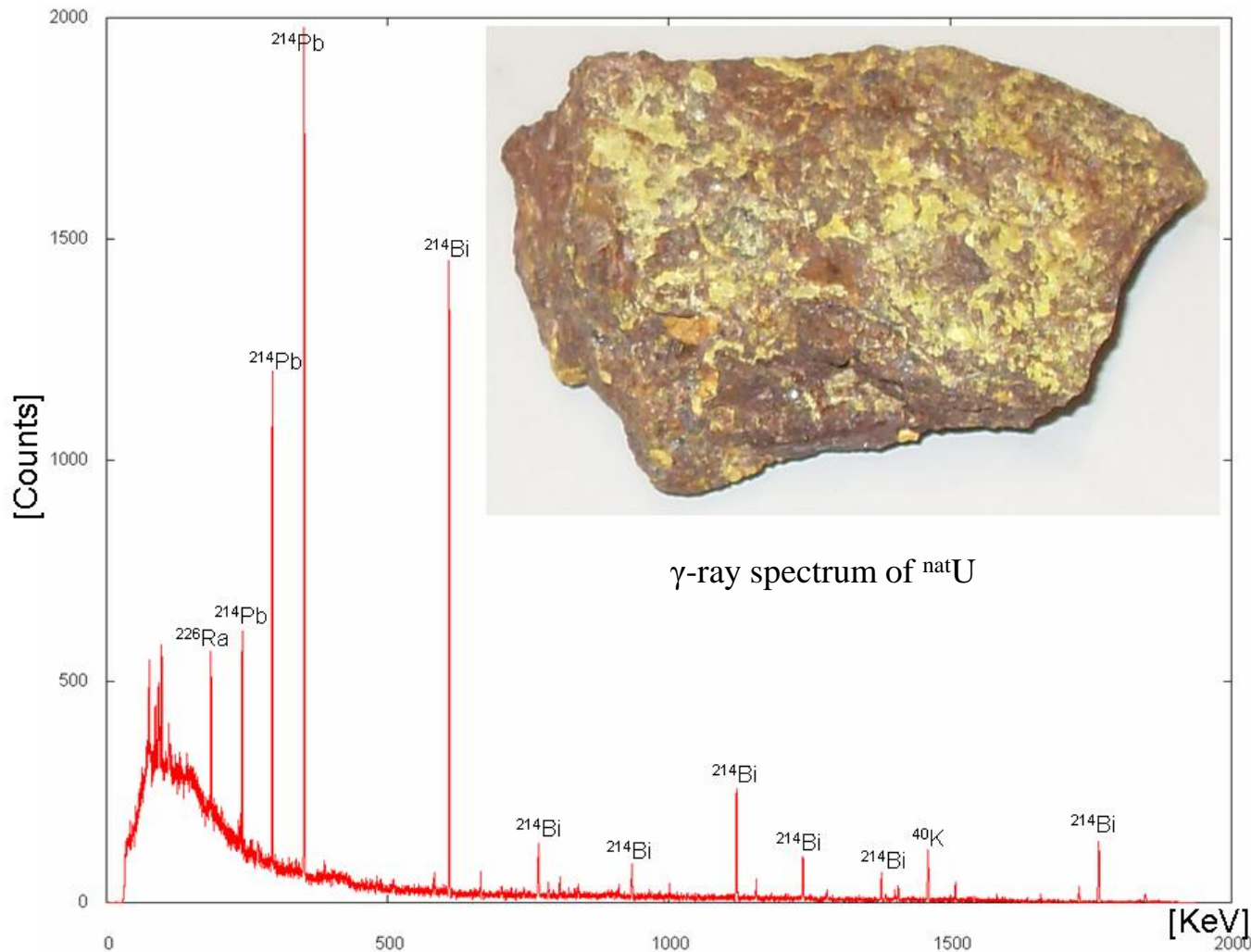

γ -ray spectrum of ^{nat}U

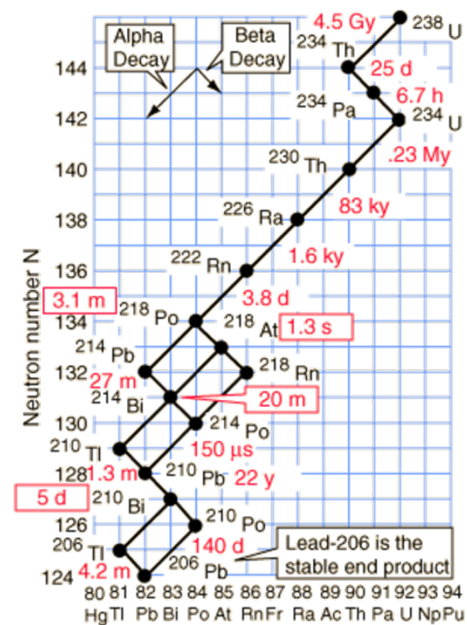

γ -decay

Most β -decay transitions are followed by γ -decay.

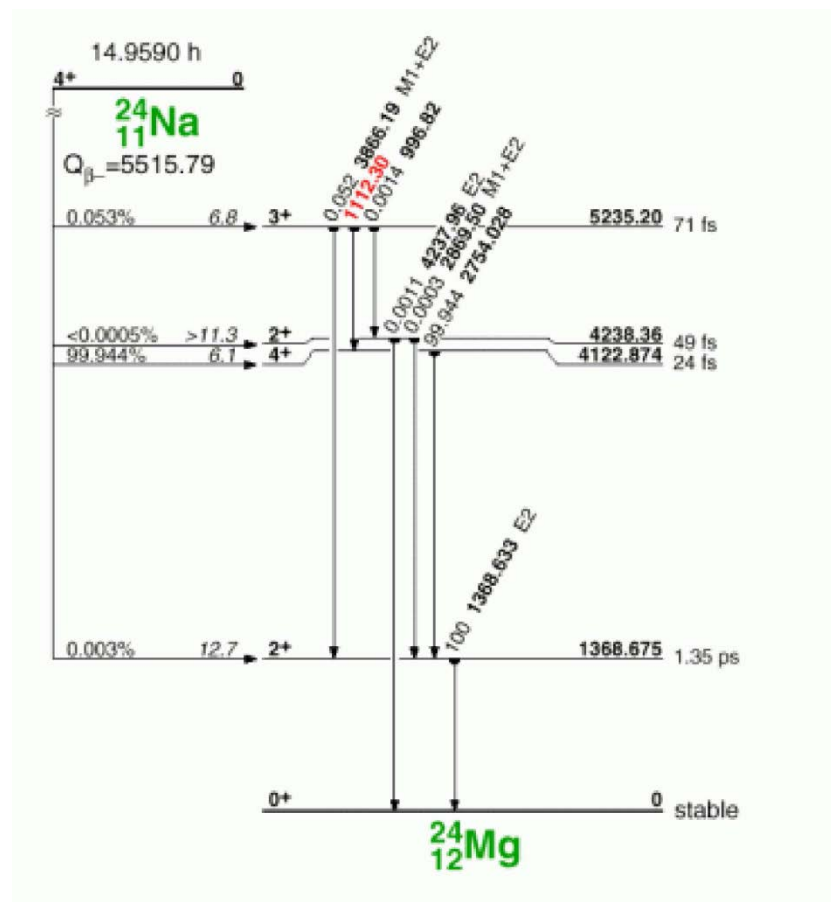

- ❖ The nucleus is a collection of moving charges, which can induce magnetic/electric fields
- ❖ The power radiated into a small area element is proportional to $\sin^2(\theta)$
- ❖ The average power radiated for an electric dipole is:

$$P = \frac{1}{12\pi\epsilon_0} \frac{\omega^4}{c^3} d^2$$

- ❖ For a magnetic dipole is

$$P = \frac{1}{12\pi\epsilon_0} \frac{\omega^4}{c^5} \mu^2$$

Electric/Magnetic Dipoles

Electric and magnetic dipole fields have opposite parity:
Magnetic dipoles have even parity and electric dipole fields have odd parity.

$$\Rightarrow \pi(M\ell) = (-1)^{\ell+1} \quad \text{and} \quad \pi(E\ell) = (-1)^\ell$$

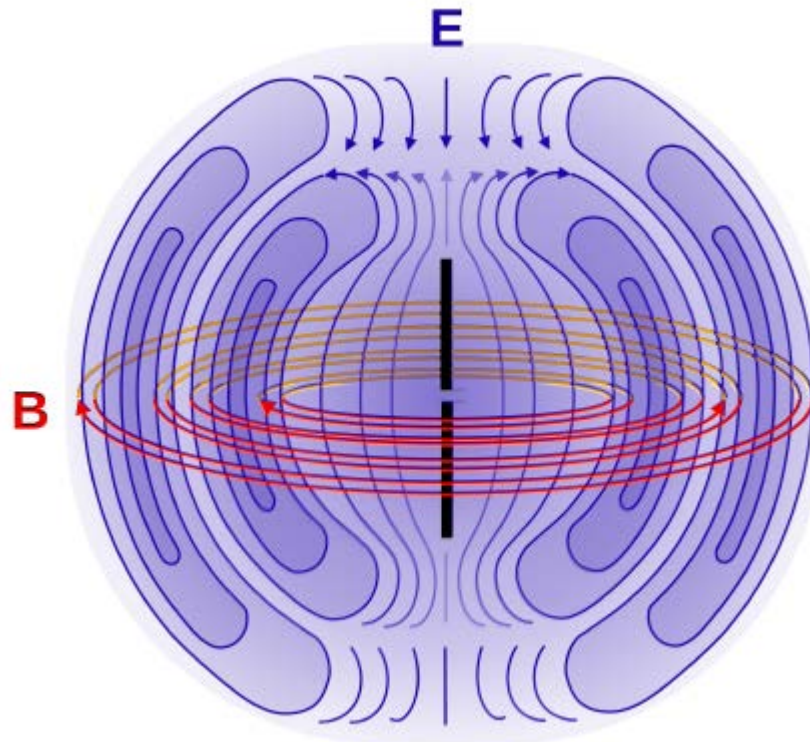

Higher Order Multipoles

It is possible to describe the angular distribution of the radiation field as a function of the *multipole order* using Legendre polynomials.

- ℓ : The index of radiation
 2^ℓ : The multipole order of the radiation
- $\ell = 1 \rightarrow \text{Dipole}$
 $\ell = 2 \rightarrow \text{Quadrupole}$
 $\ell = 3 \rightarrow \text{Octupole}$
- The associated Legendre polynomials $P_{2\ell}(\cos(\theta))$ are:
For $\ell = 1$: $P_2 = \frac{1}{2}(3 \cdot \cos^2(\theta) - 1)$
For $\ell = 2$: $P_4 = \frac{1}{8}(35\cos^4(\theta) - 30\cos^2(\theta) + 3)$

Angular Momentum in γ -Decay

- ❖ *The photon is a spin-1 boson*
- ❖ Like α -decay and β -decay the emitted γ -ray can carry away units of *angular momentum* ℓ , which has given us different multipolarities for transitions.
- ❖ For orbital angular momentum, we can have values $\ell = 0, 1, 2, 3, \dots$ that correspond to our multipolarity.
- ❖ Therefore, our selection rule is:

$$|J_i - J_f| \leq \ell \leq |J_i + J_f|$$

Characteristics of multipolarity

L	multipolarity	$\pi(E\ell) / \pi(M\ell)$	angular distribution
1	dipole	-1 / +1	
2	quadrupole	+1 / -1	
3	octupole	-1 / +1	
4	hexadecapole	+1 / -1	
⋮			

$\ell = 1$

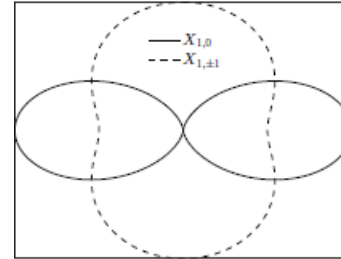

$\ell = 2$

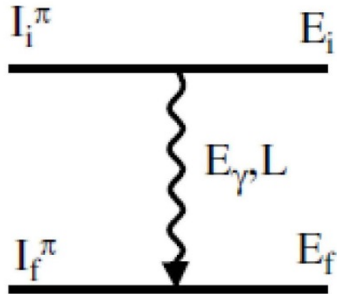
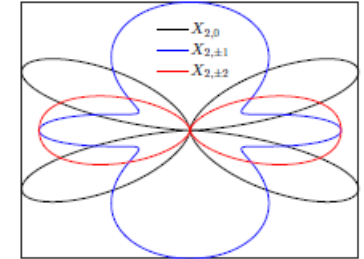

$$E_\gamma = E_i - E_f$$

$$|I_i - I_f| \leq \ell \leq I_i + I_f$$

$$\Delta\pi(E\ell) = (-1)^\ell$$

$$\Delta\pi(M\ell) = (-1)^{\ell+1}$$

The basics of the situation

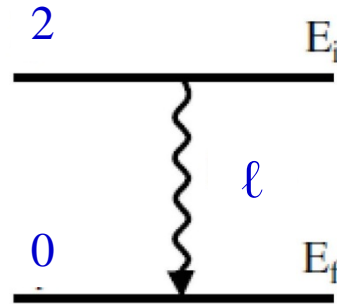

$$|2 - 0| \leq \ell \leq 2 + 0$$

Here $\Delta J = 2$ and $\ell = 2$
this is a stretched transition

The basics of the situation

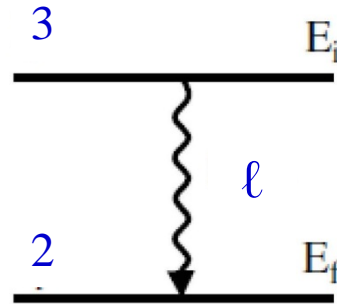

$$|3 - 2| \leq \ell \leq 3 + 2$$

Here $\Delta J = 1$ but $\ell = 1, 2, 3, 4, 5$
and the transition can be a mix of 5 multipolarities

The basics of the situation

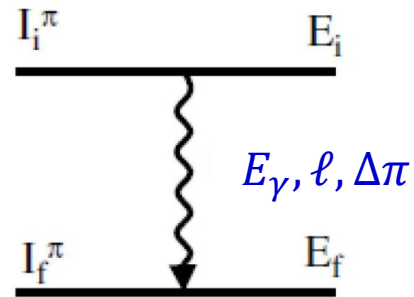

Electromagnetic transitions:

$$\Delta\pi (\text{electric}) = (-1)^\ell$$

$$\Delta\pi (\text{magnetic}) = (-1)^{\ell+1}$$

$\Delta\pi$	yes	E1	M2	E3	M4
	no	M1	E2	M3	E4

The basics of the situation

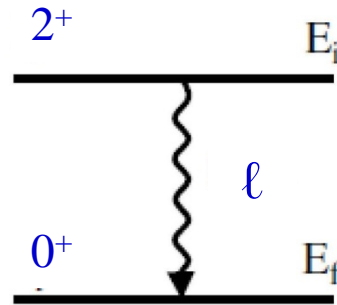

$$|2 - 0| \leq \ell \leq 2 + 0$$

$\ell = 2$ and no change in parity

$\Delta\pi$					
	no	M1	E2	M3	E4

The basics of the situation

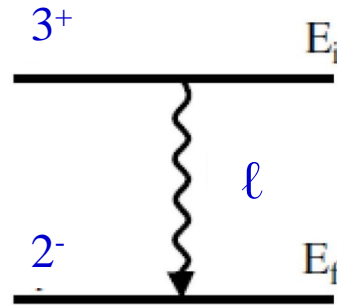

$$|3 - 2| \leq \ell \leq 3 + 2$$

Here $\Delta J = 1$ but $\ell = 1, 2, 3, 4, 5$

$\Delta\pi$	yes	E1	M2	E3	M4

mixed E1, M2, E3, M4, E5

The basics of the situation

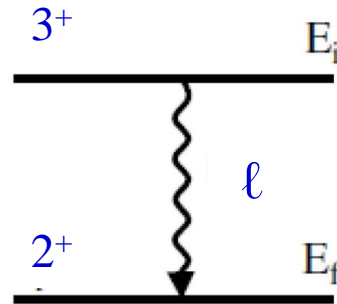

$$|3 - 2| \leq \ell \leq 3 + 2$$

Here $\Delta J = 1$ but $\ell = 1, 2, 3, 4, 5$

$\Delta\pi$					
	no	M1	E2	M3	E4

mixed M1,E2,M3,E4,M5

The basics of the situation

$3^+ \rightarrow 2^-$: mixed M1,E2,M3,E4,M5

$3^+ \rightarrow 2^+$: mixed E1,M2,E3,M4,E5

In general only the lowest 2 multipoles compete

and (for reasons we will see later)

$\ell + 1$ multipole generally only competes if it is electric:

$3^+ \rightarrow 2^+$: mixed M1/E2

$3^+ \rightarrow 2^-$: almost pure E1 (very little M2 admixture)

Characteristics of multipolarity

L	multipolarity	$\pi(E\ell) / \pi(M\ell)$	angular distribution
1	dipole	-1 / +1	
2	quadrupole	+1 / -1	
3	octupole	-1 / +1	
4	hexadecapole	+1 / -1	
⋮			

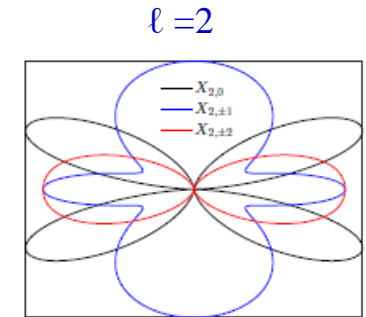
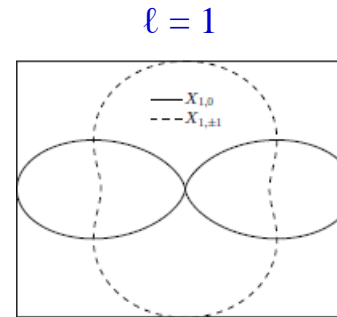

parity: electric multipoles $\pi(E\ell) = (-1)^\ell$, magnetic multipoles $\pi(M\ell) = (-1)^{\ell+1}$

The **power radiated** is proportional to:

$$P(\sigma\ell) \propto \frac{2(\ell + 1) \cdot c}{\varepsilon_0 \cdot \ell \cdot [(2\ell + 1)!!]^2} \left(\frac{\omega}{c}\right)^{2\ell+2} |\mathcal{M}(\sigma\ell)|^2$$

where σ means either E or M and $\mathcal{M}(\sigma\ell)$ is the E or M multipole moment of the appropriate kind.

Emission of electromagnetic radiation

$$T(E1; I_i \rightarrow I_f) = 1.590 \cdot 10^{17} E_\gamma^3 B(E1; I_i \rightarrow I_f)$$

$$T(E2; I_i \rightarrow I_f) = 1.225 \cdot 10^{13} E_\gamma^5 B(E2; I_i \rightarrow I_f)$$

$$T(E3; I_i \rightarrow I_f) = 5.709 \cdot 10^8 E_\gamma^7 B(E3; I_i \rightarrow I_f)$$

$$T(E4; I_i \rightarrow I_f) = 1.697 \cdot 10^4 E_\gamma^9 B(E4; I_i \rightarrow I_f)$$

$$T(M1; I_i \rightarrow I_f) = 1.758 \cdot 10^{13} E_\gamma^3 B(M1; I_i \rightarrow I_f)$$

$$T(M2; I_i \rightarrow I_f) = 1.355 \cdot 10^7 E_\gamma^5 B(M2; I_i \rightarrow I_f)$$

$$T(M3; I_i \rightarrow I_f) = 6.313 \cdot 10^0 E_\gamma^7 B(M3; I_i \rightarrow I_f)$$

$$T(M4; I_i \rightarrow I_f) = 1.877 \cdot 10^{-6} E_\gamma^9 B(M4; I_i \rightarrow I_f)$$

where $E_\gamma = E_i - E_f$ is the energy of the emitted γ quantum in MeV (E_i, E_f are the nuclear level energies, respectively), and the reduced transition probabilities $B(E\ell)$ in units of $e^2(\text{barn})^\ell$ and $B(M\ell)$ in units of $\mu_N^2 = (e\hbar/2m_Nc)^2 (fm)^{2\ell-2}$

Single particle transition (Weisskopf estimate)

$$B(E\lambda; I_i \rightarrow I_{gs}) = \frac{(1.2)^{2\lambda}}{4\pi} \left(\frac{3}{\lambda+3}\right)^2 A^{2\lambda/3} e^2 (fm)^{2\lambda}$$

$$B(M\lambda; I_i \rightarrow I_{gs}) = \frac{10}{\pi} (1.2)^{2\lambda-2} \left(\frac{3}{\lambda+3}\right)^2 A^{(2\lambda-2)/3} \mu_N^2 (fm)^{2\lambda-2}$$

For the first few values of λ , the Weisskopf estimates are

$$B(E1; I_i \rightarrow I_{gs}) = 6.446 \cdot 10^{-4} A^{2/3} e^2 (\text{barn})$$

$$B(E2; I_i \rightarrow I_{gs}) = 5.940 \cdot 10^{-6} A^{4/3} e^2 (\text{barn})^2$$

$$B(E3; I_i \rightarrow I_{gs}) = 5.940 \cdot 10^{-8} A^2 e^2 (\text{barn})^3$$

$$B(E4; I_i \rightarrow I_{gs}) = 6.285 \cdot 10^{-10} A^{8/3} e^2 (\text{barn})^4$$

$$B(M1; I_i \rightarrow I_{gs}) = 1.790 \left(\frac{e\hbar}{2Mc}\right)^2$$

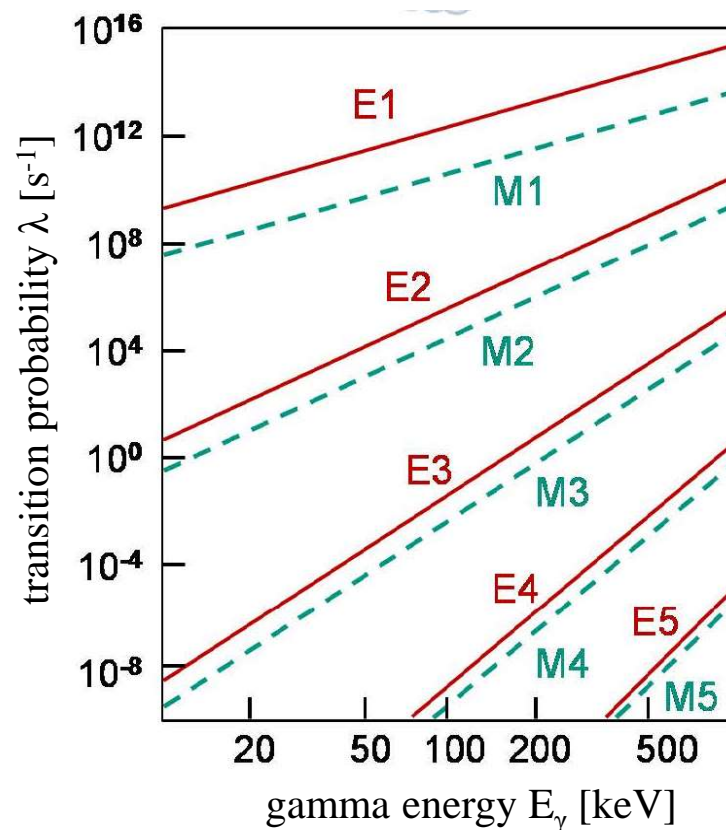

Conversion electrons

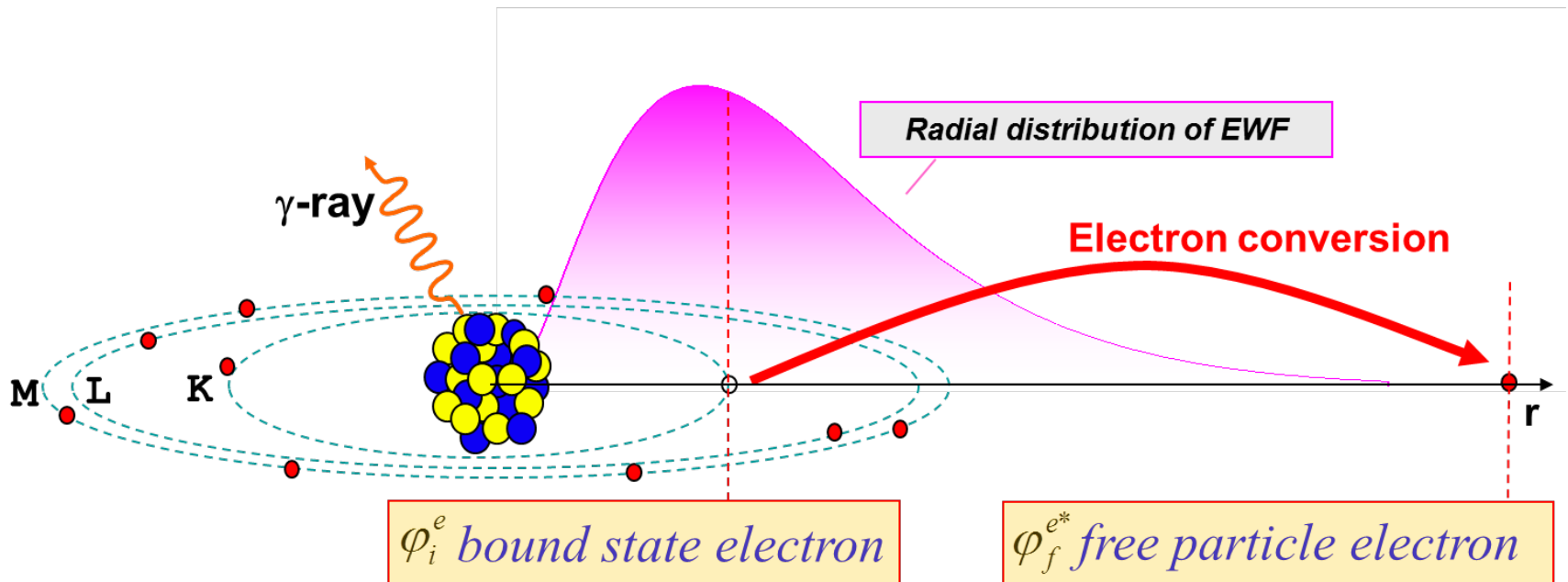

Energetics of CE-decay ($i=K, L, M, \dots$)

$$E_i = E_f + E_{ce,i} + E_{BE,i}$$

γ - and CE-decays are independent; transition probability ($\lambda \sim$ Intensity)

$$\lambda_T = \lambda_\gamma + \lambda_{CE} = \lambda_\gamma + \lambda_K + \lambda_L + \lambda_M + \dots$$

Conversion coefficient

$$\alpha_i = \frac{\lambda_{CE,i}}{\lambda_\gamma}$$

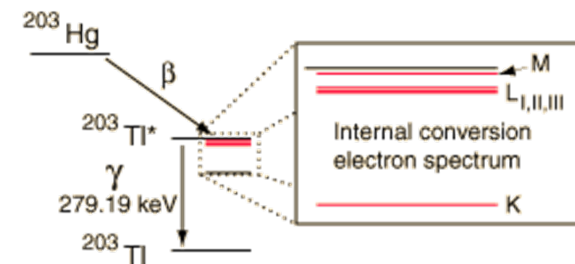

Internal conversion

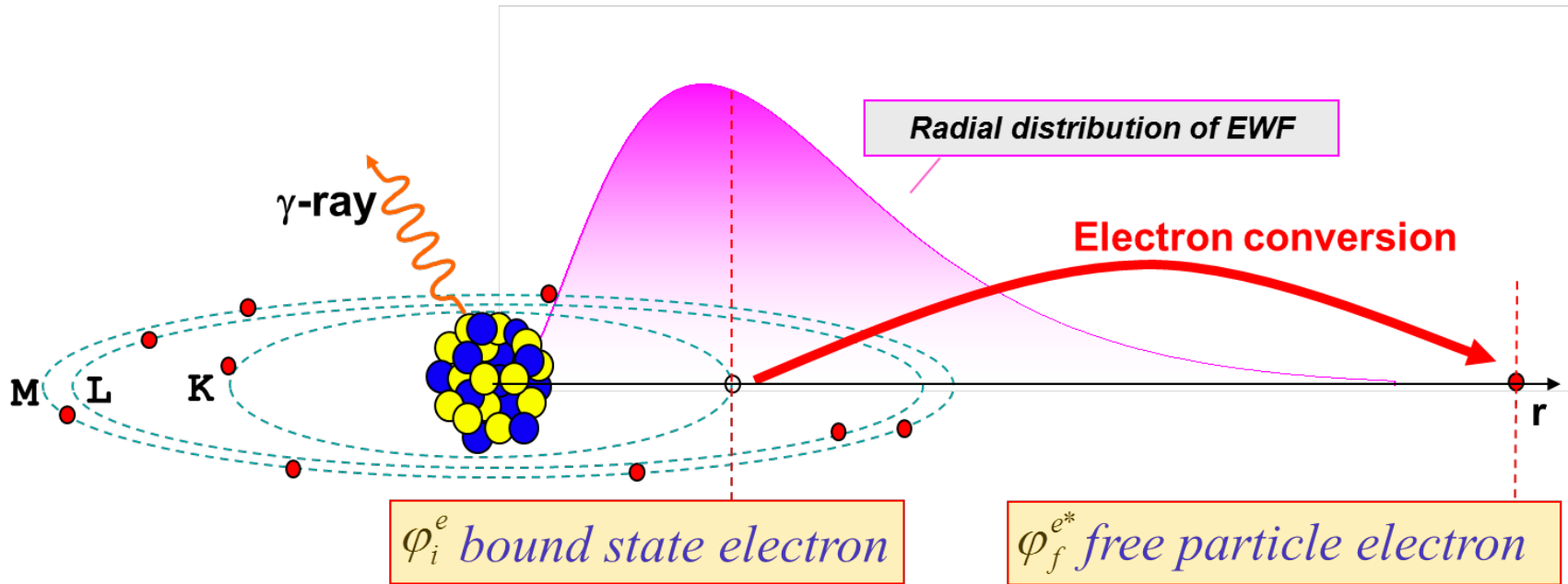

- ❖ For an electromagnetic transition internal conversion can occur instead of emission of gamma radiation. In this case the transition energy $Q = E_\gamma$ will be transferred to an electron of the atomic shell.

$$T_e = E_\gamma - B_e$$

T_e : kinetic energy of the electron
 B_e : binding energy of the electron

internal conversion is important for:

- heavy nuclei $\sim Z^3$
- high multiplicities $E\ell$ or $M\ell$
- small transition energies

$$\alpha_k(E\ell) \propto Z^3 \left(\frac{L}{L+1} \right) \left(\frac{2m_e c^2}{E} \right)^{L+5/2}$$

Electron spectroscopy

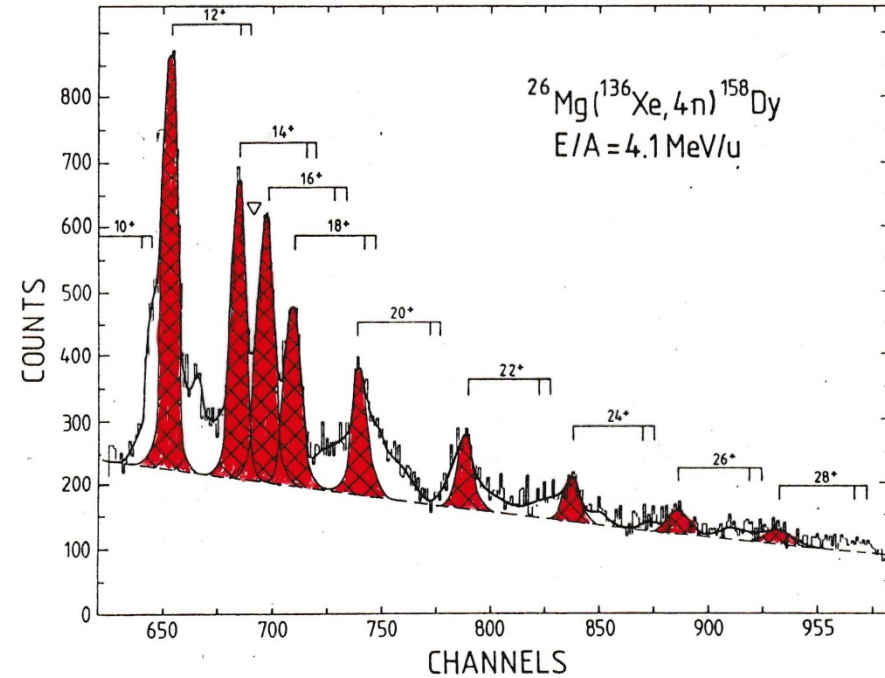
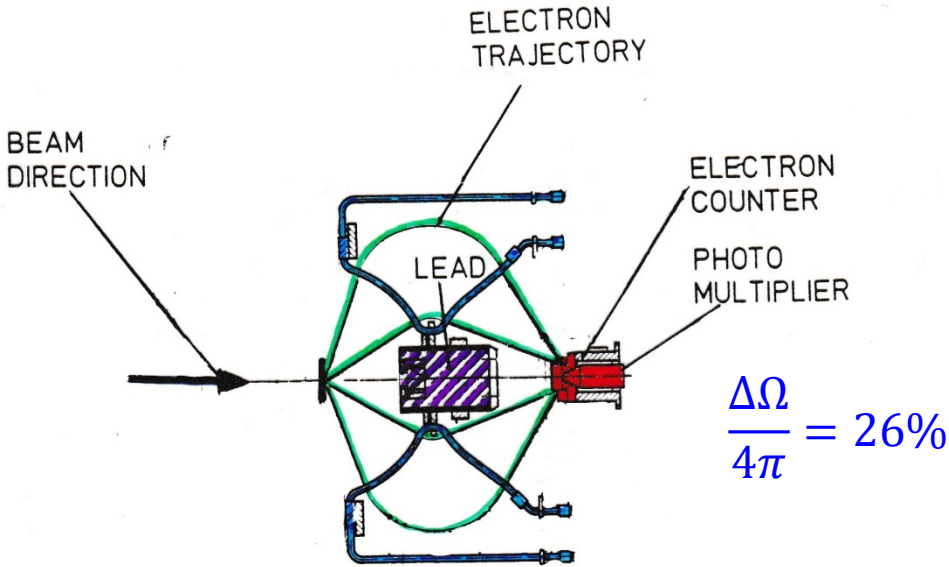

Doppler shift correction for projectile:

$$T_e^* = \gamma \cdot T_e \cdot \left\{ 1 - \beta_1 \cdot \sqrt{1 + 2m_e c^2 / T_e} \cdot \cos\theta_{e1} \right\} + m_e c^2 \cdot (\gamma - 1)$$

$$\cos\theta_{e1} = \cos\vartheta_1 \cos\vartheta_e + \sin\vartheta_1 \sin\vartheta_e \cos(\varphi_e - \varphi_1)$$

resolution of the spectrometer including Doppler correction as calculated for a point source		$(\frac{\Delta p}{p})_e / \%$
		0.4
scattering in the target	(i)	0.004
beam optics	(ii)	0.11
evaporation of neutrons	(iii)	0.09
energy loss in the target	(iv)	0.31
energy straggling of the projectiles	(v)	0.006
quadratic sum		0.53
experimental resolution		0.56 %

Mini Orange setup for conversion electron spectroscopy

Principle:

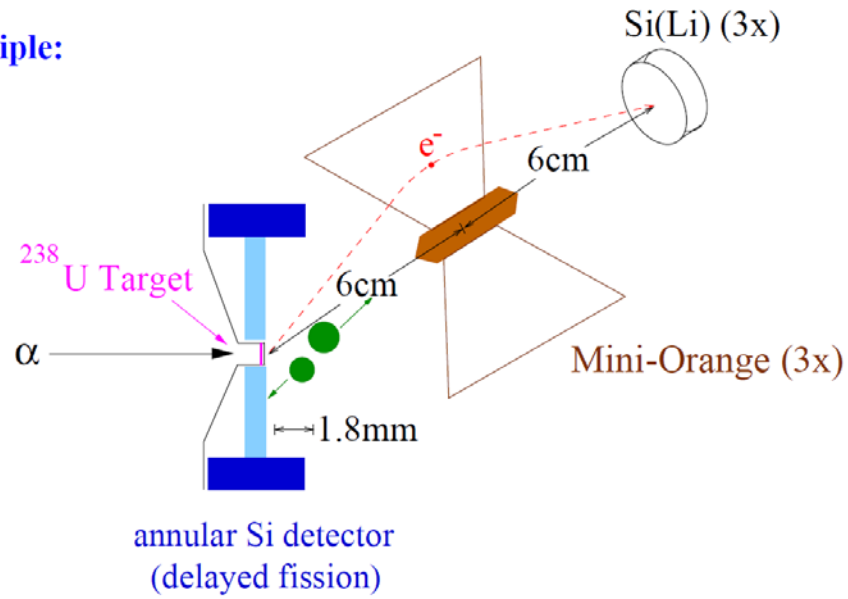

Comparison of α -decay, β -decay and γ -decay

de Broglie wavelength:
$$\lambda = \frac{h}{p} = \frac{h \cdot c}{\sqrt{E_{kin} \cdot (E_{kin} + 2mc^2)}} = \frac{1239.84[\text{MeV fm}]}{\sqrt{E_{kin} \cdot (E_{kin} + 2mc^2)}}$$

decay	Energy [MeV]	de Broglie λ [fm]
α -particle, $m_\alpha = 3727 \text{ MeV}/c^2$	5	6.42
β -particle, $m_e = 0.511 \text{ MeV}/c^2$	1	871.92
γ -photon	1	$\lambda = h \cdot c / E = 1240 / E$

For α -particles this dimension is somewhat smaller than the nucleus and this is why a semi-classical treatment of α -decay is successful.

The typical β -particle has a large wavelength λ in comparison to the nuclear size and a quantum mechanical is dictated and wave analysis is called for.

For γ -decay the wavelength λ ranges from 12400 – 1240 fm (0.1 – 1 MeV). Clearly, only a quantum mechanical approach has a chance of success.

γ -spectroscopy yields some of the most precise knowledge of nuclear structure, as spin, parity and ΔE are all measurable.

Transition rates between initial Ψ_N^* and final Ψ_N' nuclear states, resulting from electromagnetic decay producing a photon with energy E_γ can be described by Fermi's Golden rule:

$$\lambda = \frac{2\pi}{\hbar} |\langle \Psi_N' \psi_\gamma | \mathcal{M}_{em} | \Psi_N^* \rangle|^2 \frac{dn_\gamma}{dE_\gamma}$$

where \mathcal{M}_{em} is the electromagnetic transition operator and dn_γ/dE_γ is the density of final states. The photon wave function ψ_γ and \mathcal{M}_{em} are well known, therefore measurements of λ provide detailed knowledge of nuclear structure.

A γ -decay lifetime is typically 10^{-12} [s] and sometimes even as short as 10^{-19} [s]. However, this time span is an eternity in the life of an excited nucleon. It takes about $4 \cdot 10^{-22}$ [s] for a nucleon to cross the nucleus.

Interaction of gamma rays with matter

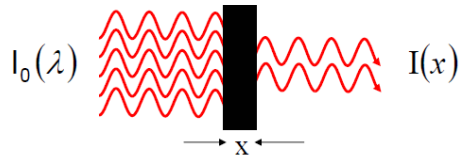

$$I(x) = I_0(\lambda) \cdot e^{-\frac{\mu(\lambda, Z)}{\rho} \rho \cdot x}$$

total absorption coefficient: μ/ρ [cm^2/g]

$$\frac{\mu_{total}}{\rho} = \sum_{i=1}^3 \sigma_i$$

- i=1 photoelectric effect
- i=2 Compton scattering
- i=3 pair production

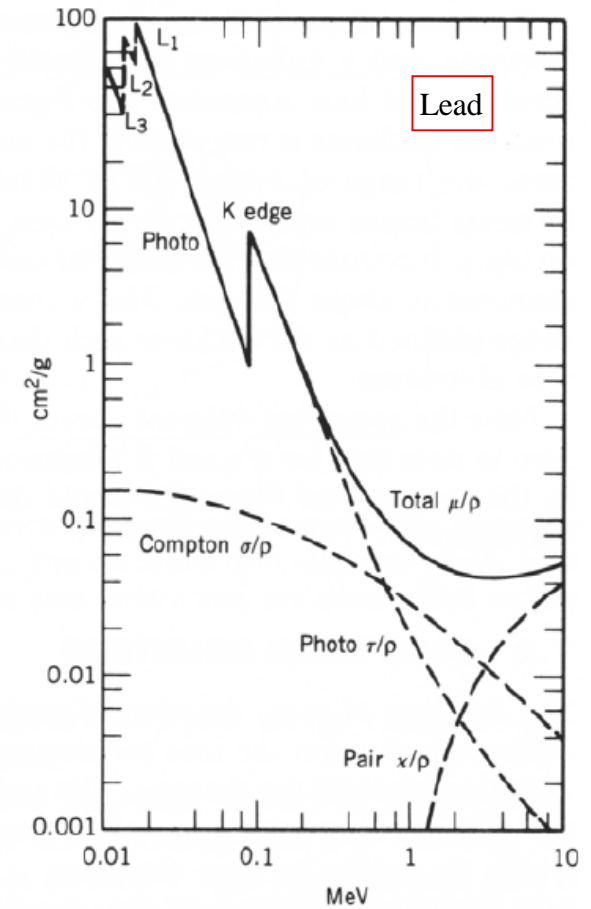
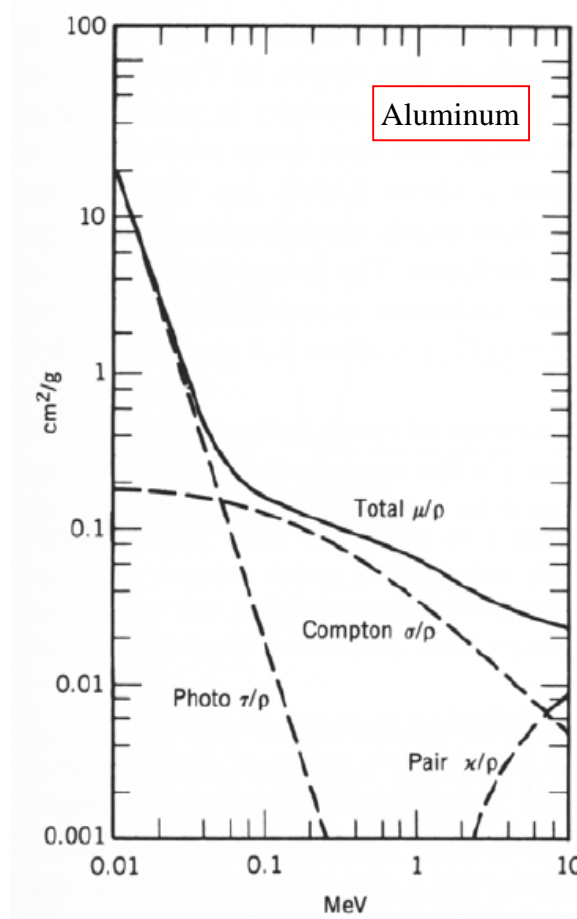

Mass dependence of X-ray absorption

For X-ray radiation the **photoelectric effect** is the most important interaction.

$$(\mu / \rho)_{\text{Photo}} \approx \lambda^3 \cdot Z^5$$

Lead absorbs more than Beryllium!

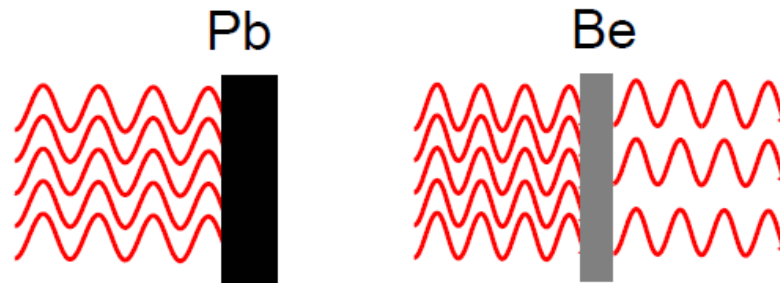

^{82}Pb serves as shielding for X-ray and γ -ray radiation; lead vests are used by medical staff people who are exposed to X-ray radiation. Co-sources are transported in thick lead container.

On the contrary:

^4Be is often used as windows in X-ray tubes to allow for almost undisturbed transmission of X-ray radiation.

Mass dependence μ/ρ of X-ray absorption

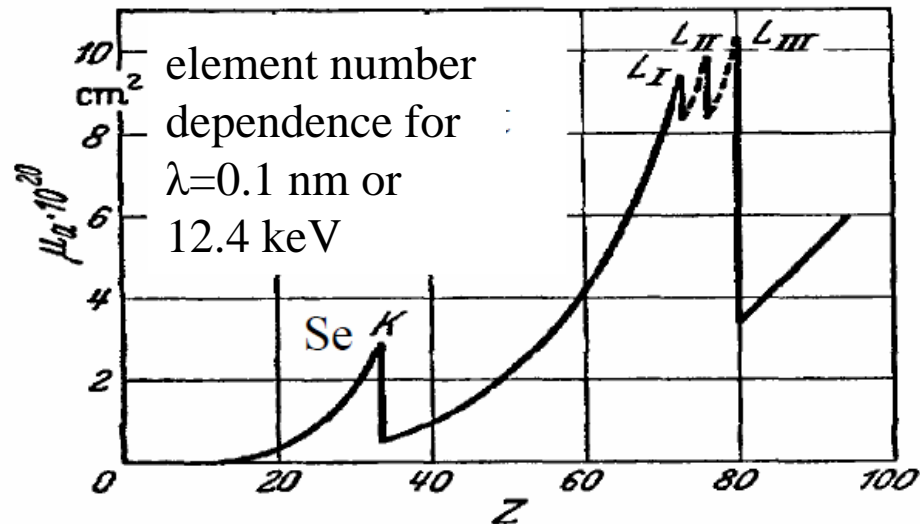
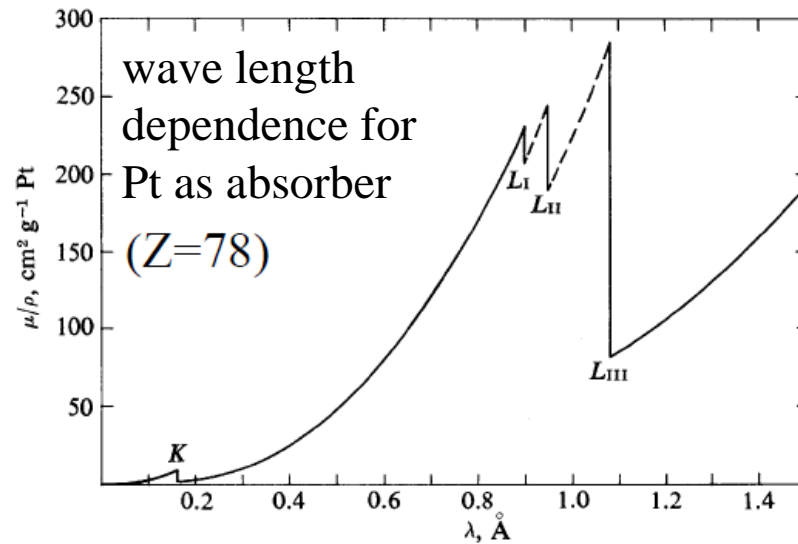

X-ray image shows the effect of different absorptions

Bones absorb more radiation as tissues because of their higher ^{20}Ca content

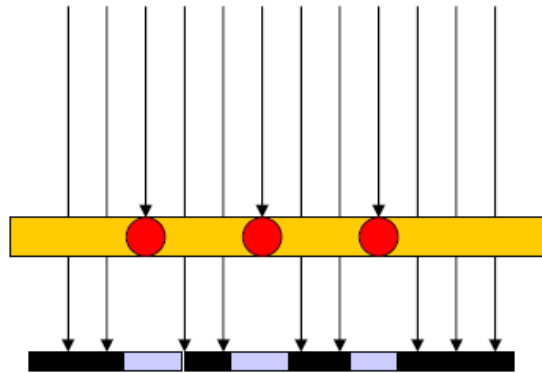

Interaction of gamma rays with matter

~ 100 keV

~1 MeV

~ 10 MeV

γ -ray energy

Photoelectric

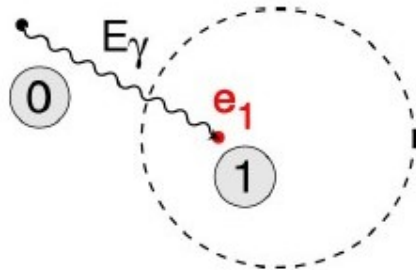

Isolated hits

Probability of
interaction depth

Interaction of gamma rays with matter

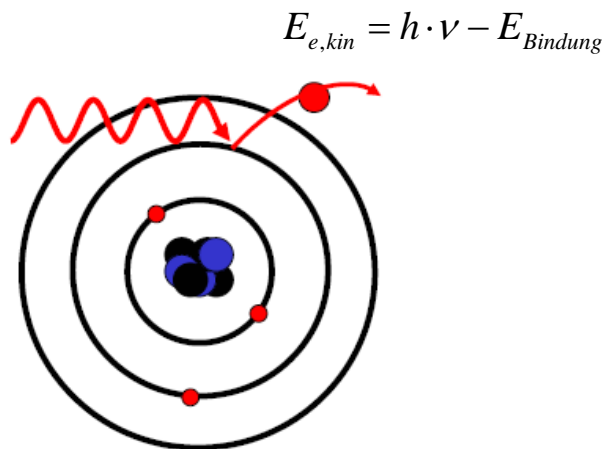
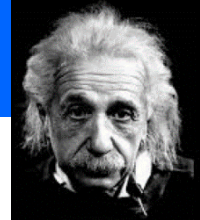
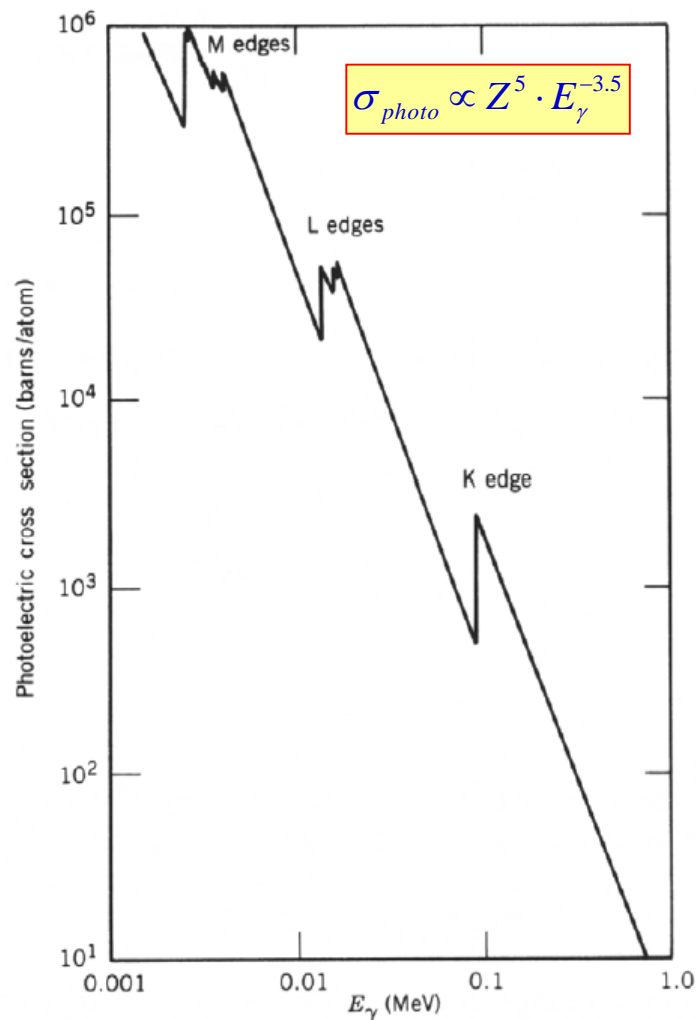
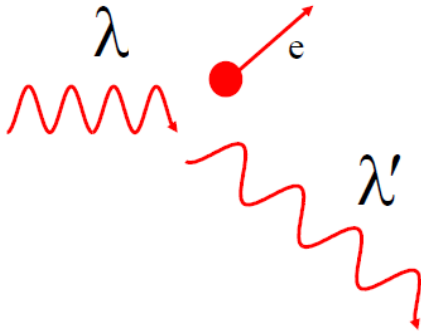
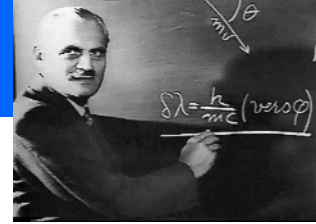

Photo effect:

Absorption of a photon by a bound electron and conversion of the γ -energy in potential and kinetical energy of the ejected electron. (Nucleus preserves the momentum conservation.)



Interaction of gamma rays with matter



relativistic $E^2 = (pc)^2 + (m_0c^2)^2$ photons: $m_0 = m_\gamma = 0$

$$\rightarrow E_\gamma = p_\gamma c$$

Momentum balance:

$$\vec{p}_e = \vec{p}_\gamma - \vec{p}'_\gamma \rightarrow |\vec{p}_e c|^2 = |(\vec{p}_\gamma - \vec{p}'_\gamma) c|^2$$

$$p_e^2 c^2 = E_\gamma^2 + E_{\gamma'}^2 - 2E_\gamma E_{\gamma'} \cdot \cos\theta$$

Energy balance:

$$E_\gamma + m_e c^2 = E_{\gamma'} + \sqrt{(p_e c)^2 + (m_e c^2)^2}$$

$$E_{\gamma'} = \frac{E_\gamma}{1 + (E_\gamma/m_e c^2)(1 - \cos\theta)}$$

Compton scattering:

Elastic scattering of a γ -ray on a free electron. A fraction of the γ -ray energy is transferred to the Compton electron. The wave length of the scattered γ -ray is increased: $\lambda' > \lambda$.

Interaction of gamma rays with matter

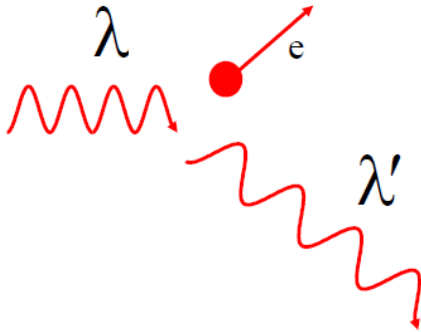
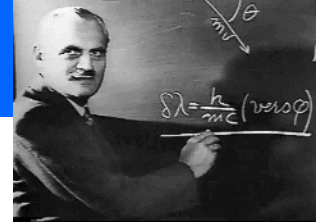

Maximum energy of the scattered electron:

$$T(e^-)_{\max} = E_\gamma \cdot \frac{2 \cdot E_\gamma}{m_e c^2 + 2 \cdot E_\gamma}$$

Energy of the scattered γ -photon:

$$E'_\gamma = \frac{E_\gamma \cdot m_e c^2}{m_e c^2 + E_\gamma \cdot (1 - \cos \theta)}$$

$$\cos \theta = 1 + \frac{m_e c^2}{E_\gamma} - \frac{m_e c^2}{E'_\gamma}$$

Special case for $E \gg m_e c^2$:
 γ -ray energy after 180° scatter
 is approximately

$$E'_\gamma = \frac{m_e c^2}{2} = 256 \text{ keV}$$

Compton scattering:

Elastic scattering of a γ -ray on a free electron. A fraction of the γ -ray energy is transferred to the Compton electron. The wave length of the scattered γ -ray is increased: $\lambda' > \lambda$.

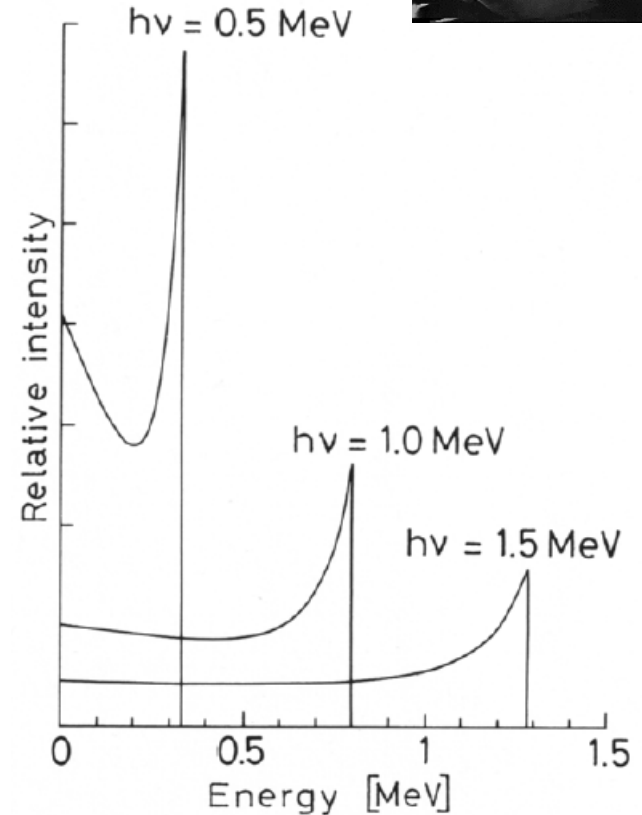

Gap between the incoming γ -ray and the maximum electron energy.

$$E_{\text{kin}}^{\max} = E_\gamma - E'_\gamma = E_\gamma \cdot \frac{2 \cdot E_\gamma / m_e c^2}{1 + 2 \cdot E_\gamma / m_e c^2}$$

Interaction of gamma rays with matter

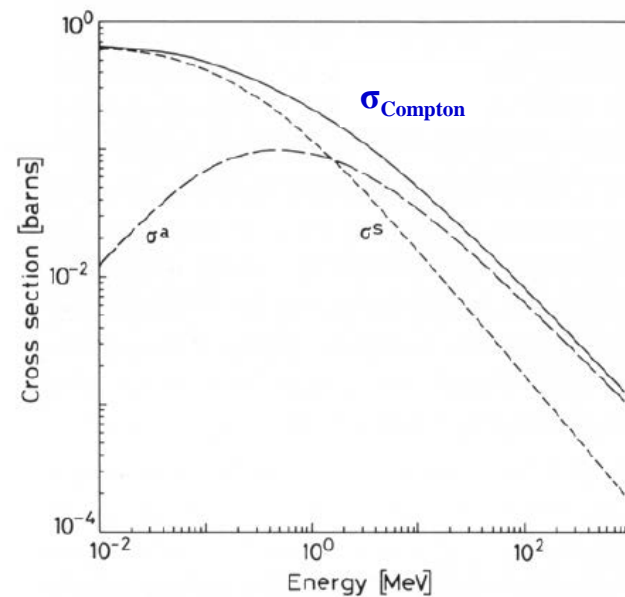
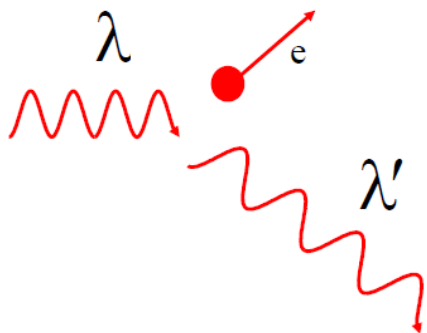

Compton scattering:

Elastic scattering of a γ -ray on a free electron. A fraction of the γ -ray energy is transferred to the Compton electron. The wave length of the scattered γ -ray is increased: $\lambda' > \lambda$.

Interaction of gamma rays with matter

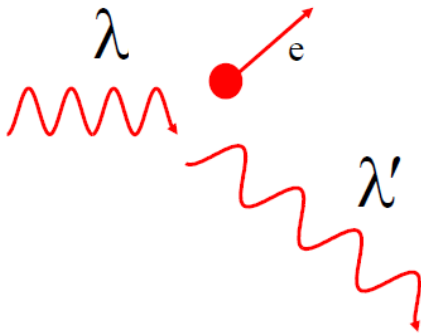

Intensity as a function of θ :

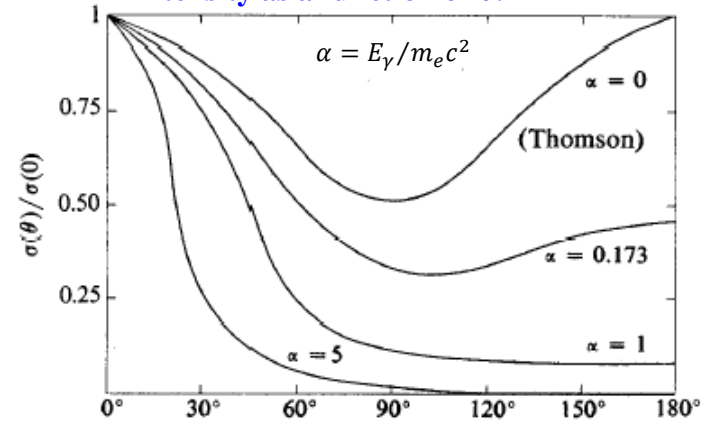

Angular distribution:

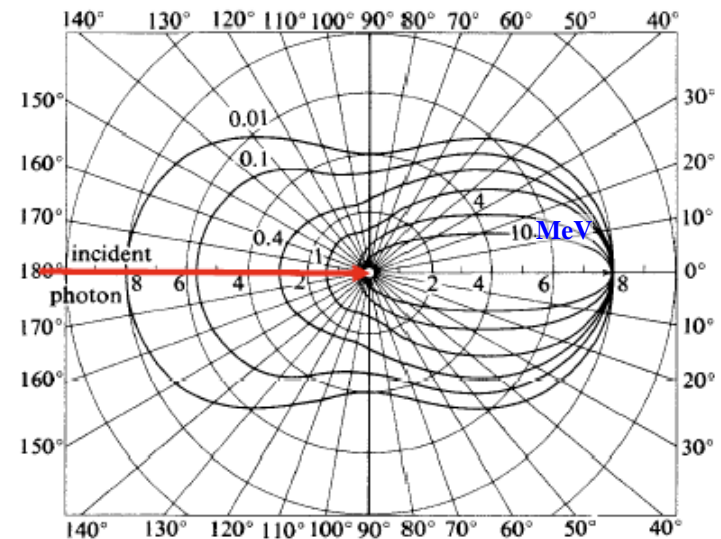

Compton scattering:

Elastic scattering of a γ -ray on a free electron.
The angle dependence is expressed by the

Klein-Nishina-Formula:

$$\frac{d\sigma_c}{d\Omega} = \frac{r_0^2}{2} \left(\frac{E_{\gamma'}}{E_\gamma} \right)^2 \cdot \left\{ \frac{E_\gamma}{E_{\gamma'}} + \frac{E_{\gamma'}}{E_\gamma} - 2 \sin^2 \theta \cdot \cos^2 \phi \right\}$$

As shown in the plot **forward scattering** (θ small) is dominant for $E_\gamma > 100$ keV.

$r_0 = 2.818$ fm (classical electron radius)

Interaction of gamma rays with matter

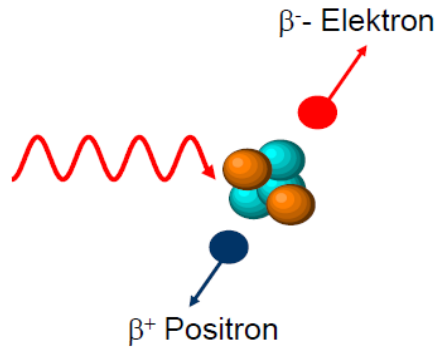

Pair production:

If γ -ray energy is $\gg 2m_0c^2$ (electron rest mass 511 keV), a positron-electron pair can be formed in the strong Coulomb field of a nucleus. This pair carries the γ -ray energy minus $2m_0c^2$.

Pair production for $E_\gamma > 2m_e c^2 = 1.022 \text{ MeV}$

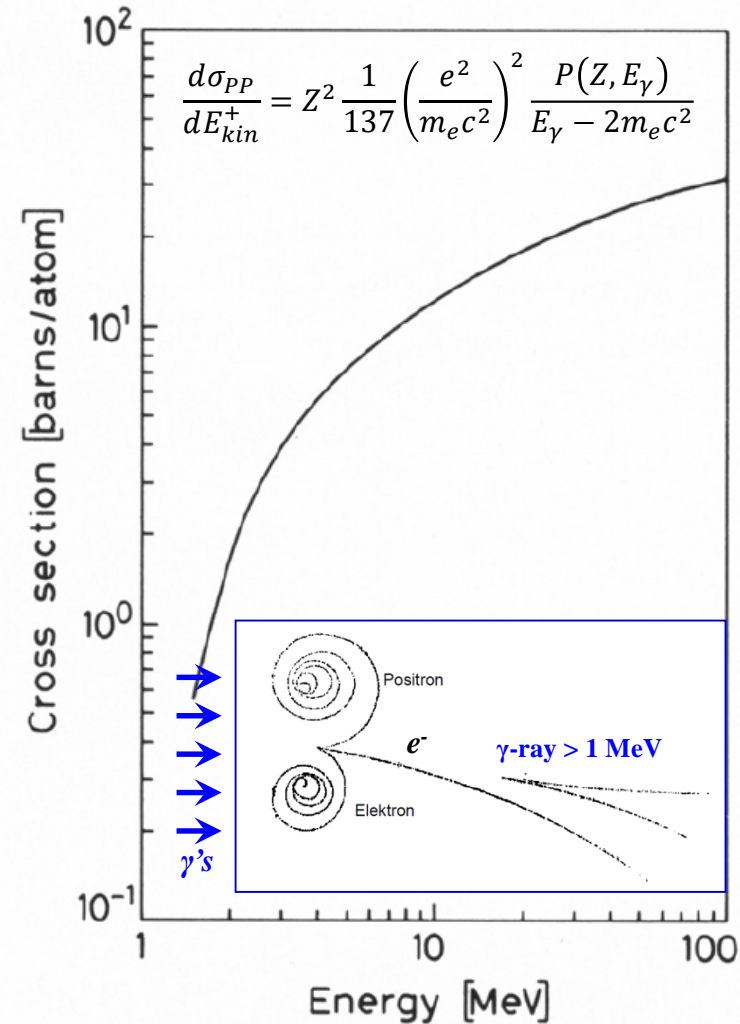

picture of a bubble chamber

Interaction of gamma rays with matter

γ -rays interaction with matter via three main reaction mechanisms:

Photoelectric absorption

Compton scattering

Pair production

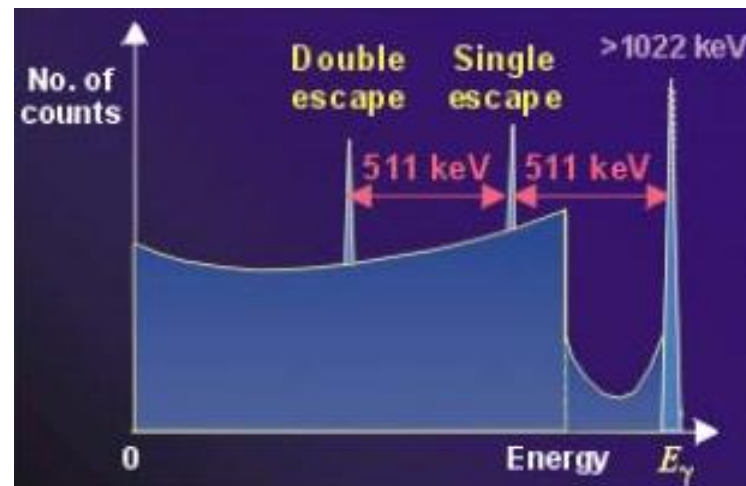
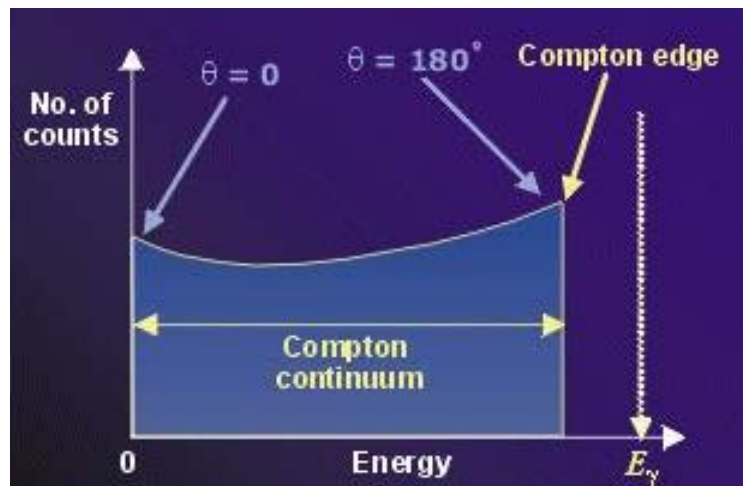
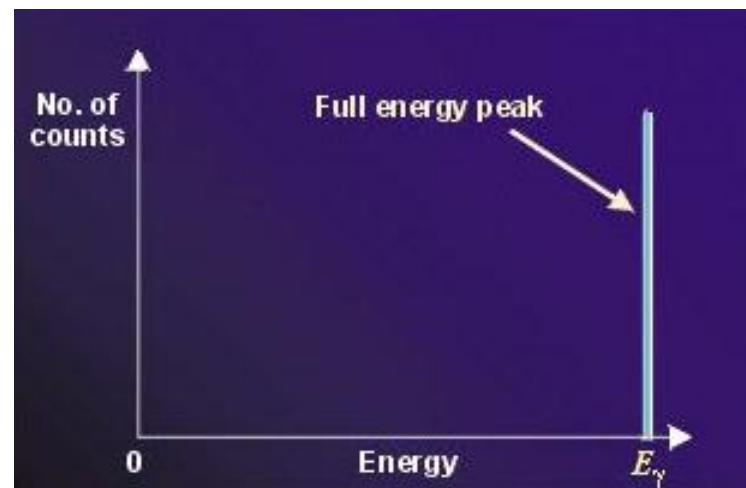

Gamma-ray interaction cross section

All three interaction (photo effect, Compton scattering and pair production) lead to an attenuation of the γ -ray or X-ray radiation when passing through matter. The particular contribution depends on the γ -ray energy:

Photo effect: $\sim Z^{4-5}, E_{\gamma}^{-3.5}$
Compton: $\sim Z, E_{\gamma}^{-1}$
Pair: $\sim Z^2$, increases with E_{γ}

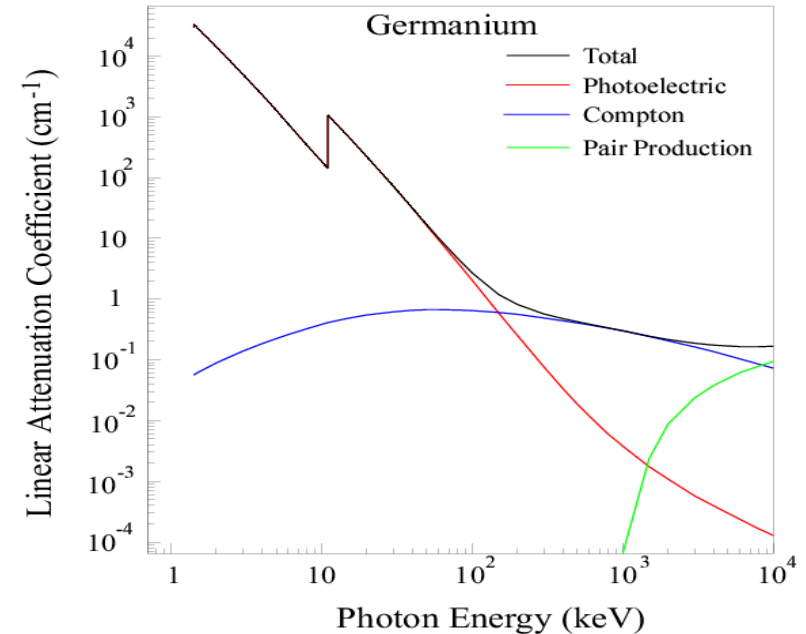
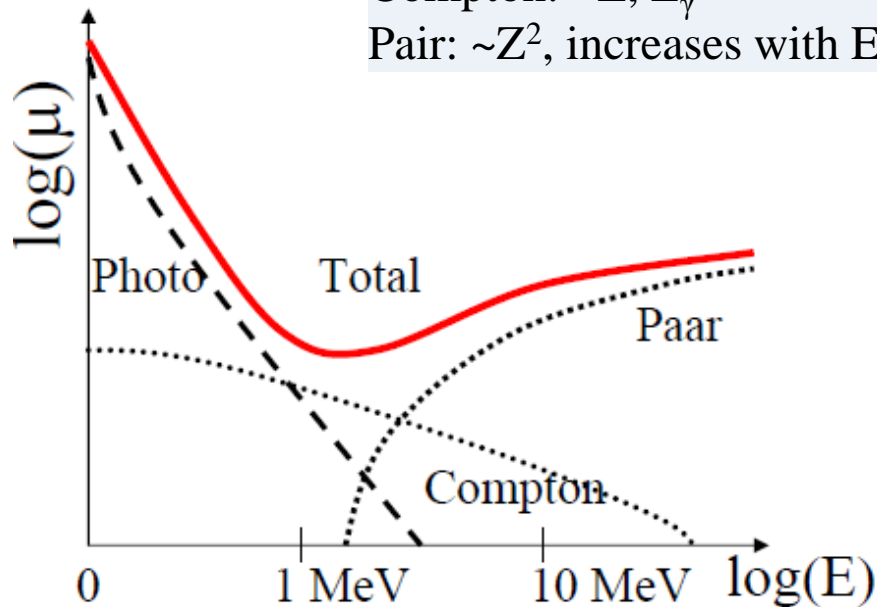

The absorption attenuates the intensity, but the energy and the frequency of the γ -ray and X-ray radiation is preserved!

Z dependence of interaction probabilities

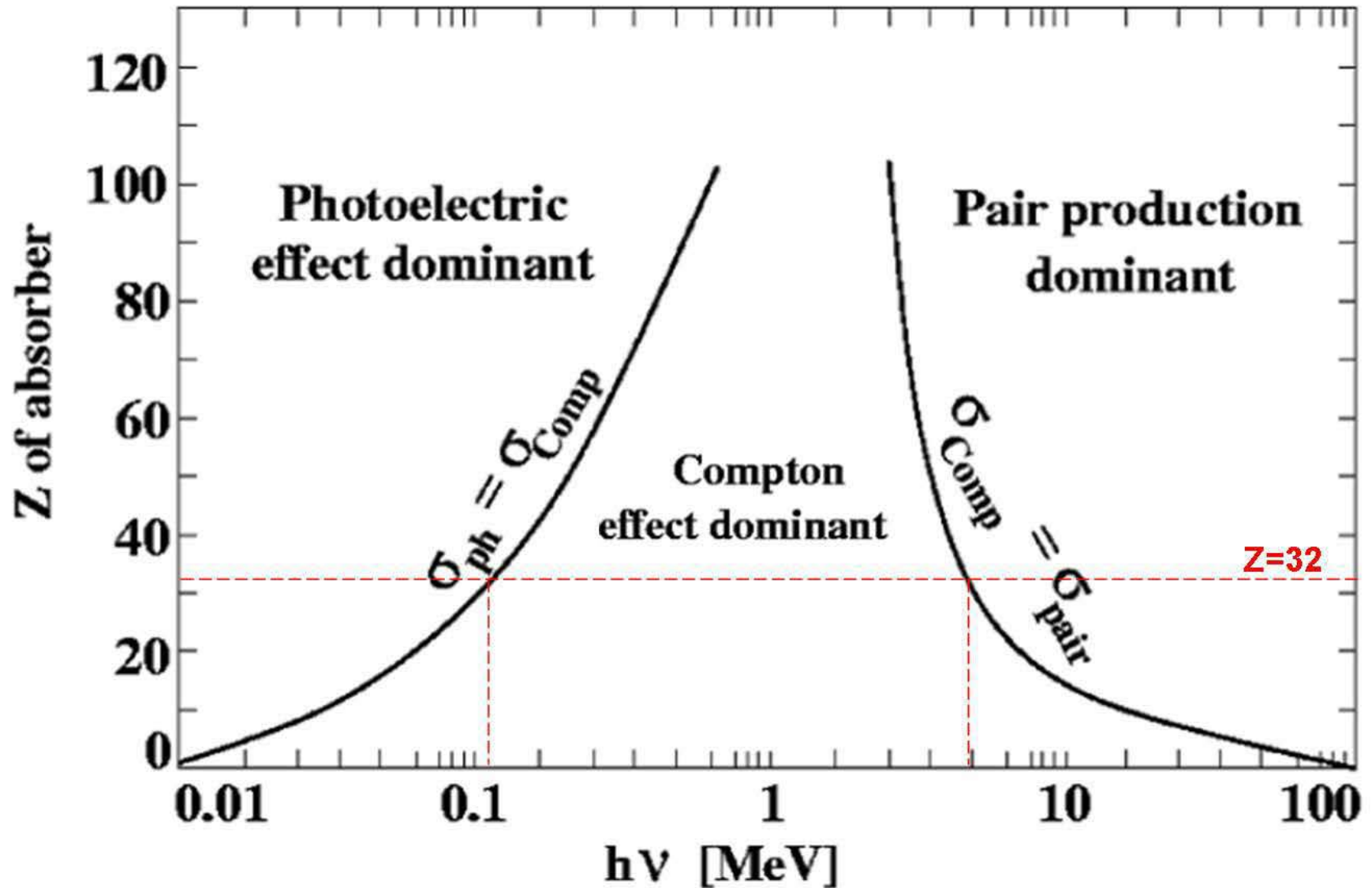

Detector types

Solid state semiconductor detectors: Ge

Electron-hole pairs are collected as charge

knock-on effect → an avalanche arrives at the electrode

lots of electrons → good energy resolution

cooled to liquid N₂ temperature (77K) to reduce noise

Advantage: good energy resolution (~0.15% FWHM at 1.3 MeV)

Disadvantage: relative low efficiency, cryogenic operation, limited size of crystal/detector

Scintillation detectors: e.g. NaI, BGO, LaBr₃(Ce)

Recoiling electrons excite atoms, which then de-excite by emitting visible light

Light is collected in photomultiplier tubes (PMT) where it generates a pulse proportional to the light collected

Advantage: good time resolution

detector can be made relative large e.g. NaI detector 14"Ø x 10"

no need for cryogenics

Disadvantage: poor energy resolution (~5% FWHM at 1.3 MeV)

Scintillation detectors

LaBr₃(Ce)

- ▶ LaBr₃(Ce) timing properties:
 - ~ 25 ns decay time
 - Timing Resolution FWHM of 130-150 ps with ⁶⁰Co for a Ø1"x1" crystal.
- ▶ High energy resolution, 3 % FWHM at 662 keV.
- ▶ Peak Emission wavelength in Blue/UV part of EM spectrum (380 nm), compatible with PMTs.

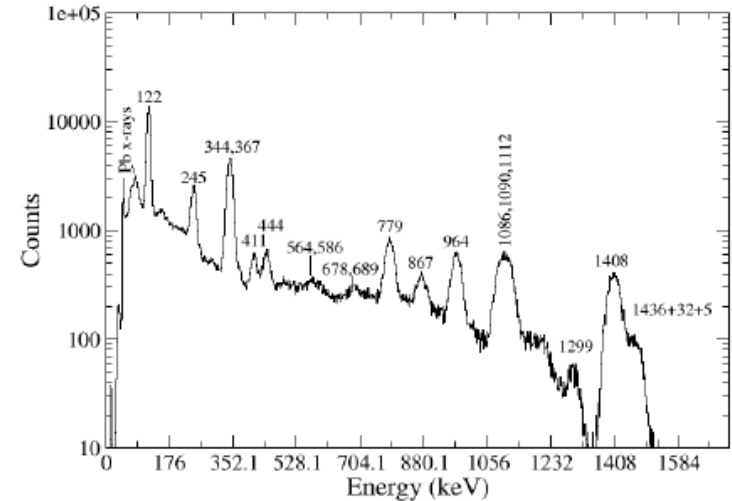

Detector characterization

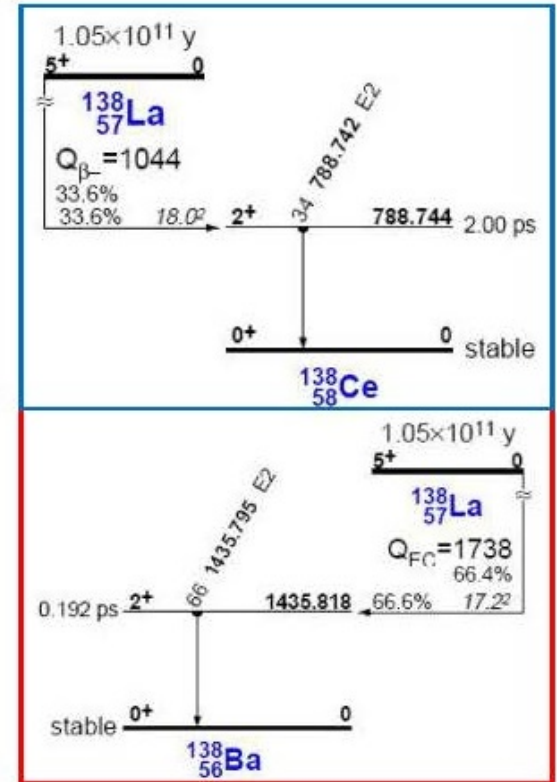
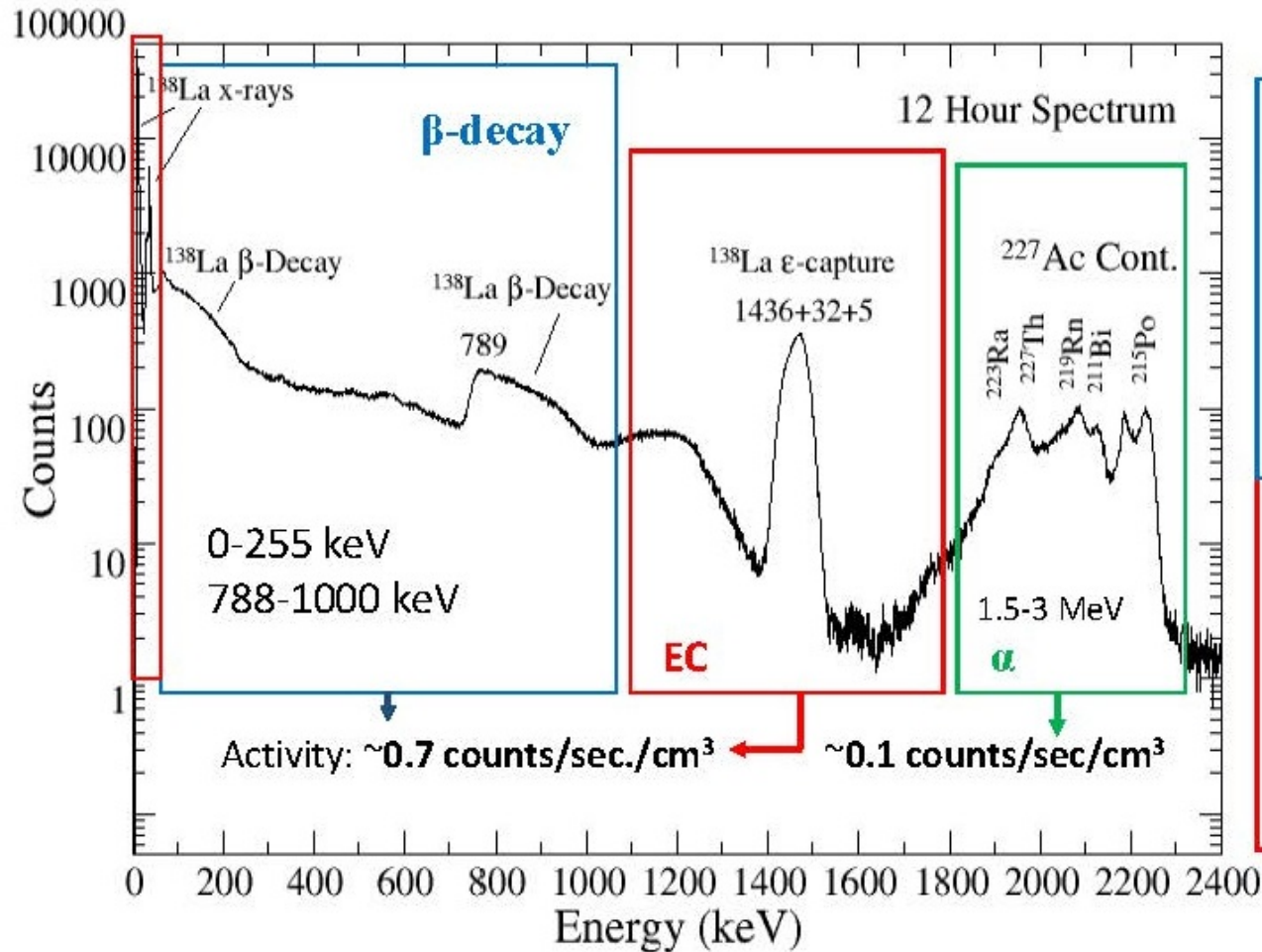

J. McIntyre et al., NIM A 652, 1, 2011, 201-204

Gamma-ray spectrum of a radioactive decay

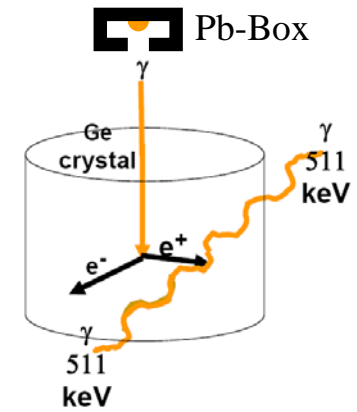
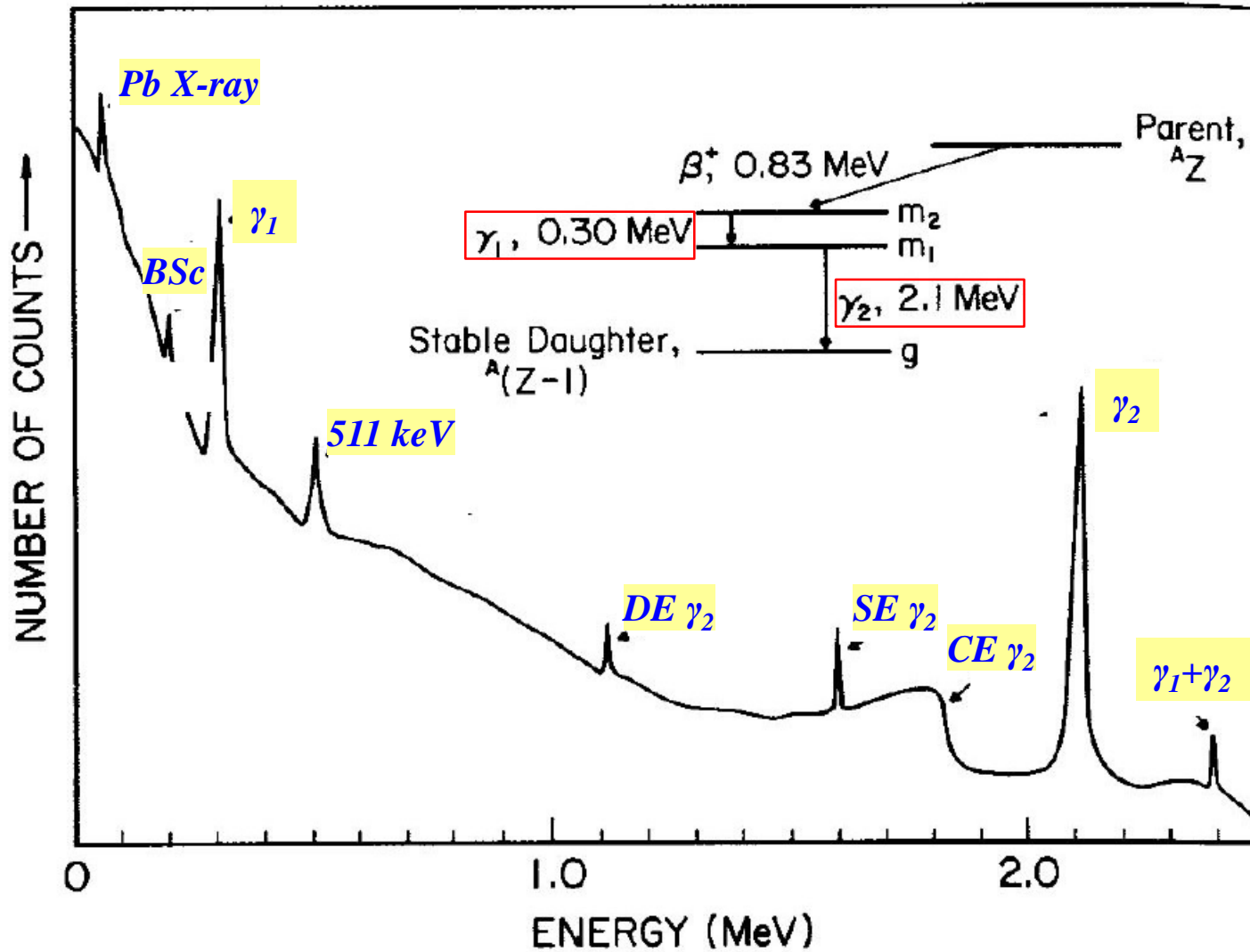

Two distinct types of measurements:

Angular correlation : can be done with a non-aligned source but need γ - γ coincidence information.

Angular distribution: need an aligned source but can be done with singles data.

...note that these cannot measure parity but you can usually infer something about the transition

The basics of the situation

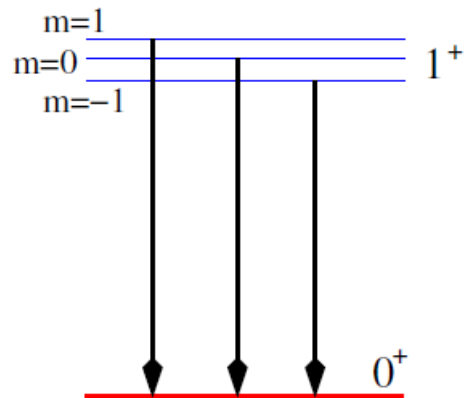

Imagine the situation of an M1 decay between two states, the initial one has J^π value of 1^+ and the final one a J^π of 0^+

The initial $J^\pi=1^+$ state has 3 degenerate magnetic substates which differ by the magnetic quantum numbers m of ± 1 and 0 .

The final $J^\pi=0^+$ state has a single magnetic substate with $m=0$.

When the substates of $J^\pi=1^+$ state decay, the γ -rays emitted have different angular patterns.

The basics of the situation

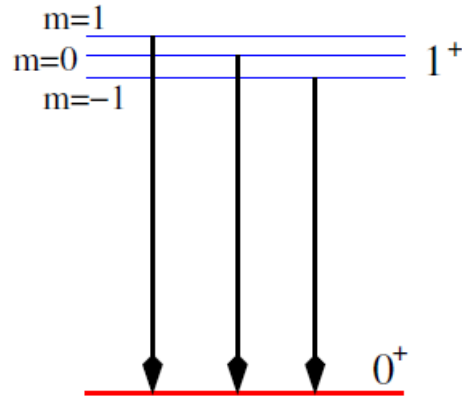

For the M1 case the angular distributions $W(\theta)$ are:

$$W_{M1, \Delta m=1}(\theta) = \frac{3}{16\pi} (1 + \cos^2 \theta)$$

$$W_{M1, \Delta m=0}(\theta) = \frac{3}{8\pi} \sin^2 \theta$$

$$W_{M1, \Delta m=-1}(\theta) = \frac{3}{16\pi} (1 + \cos^2 \theta)$$

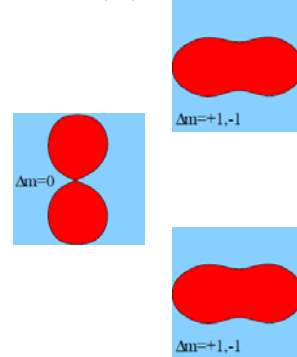

So the total distribution is

$$W_{M1} = \frac{1}{3} W_{M1, \Delta m=1} + \frac{1}{3} W_{M1, \Delta m=0} + \frac{1}{3} W_{M1, \Delta m=-1}$$

$$= \frac{1}{8\pi} (1 + \cos^2 \theta + \sin^2 \theta) = \frac{1}{4\pi}$$



no angular dependence

Angular correlation – non-oriented source

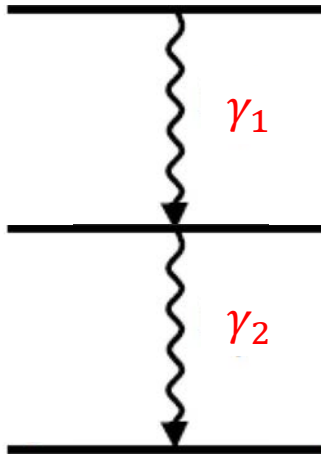

Let's imagine we have two γ -rays which follow immediately after each other in the level scheme.

If we measure γ_1 or γ_2 in singles, then the distribution will be **isotropic** (same intensity at all angles) ... there is no preferred direction of emission

Now imagine that we measure γ_1 and γ_2 in coincidence. We say that measuring γ_1 **causes the intermediate state to be aligned**. We define the z-direction as the direction of γ_1

The angular distribution of the **emission of γ_2 then depends on the spin/parities** of the states involved and on the multipolarity of the transition.

A simple example:

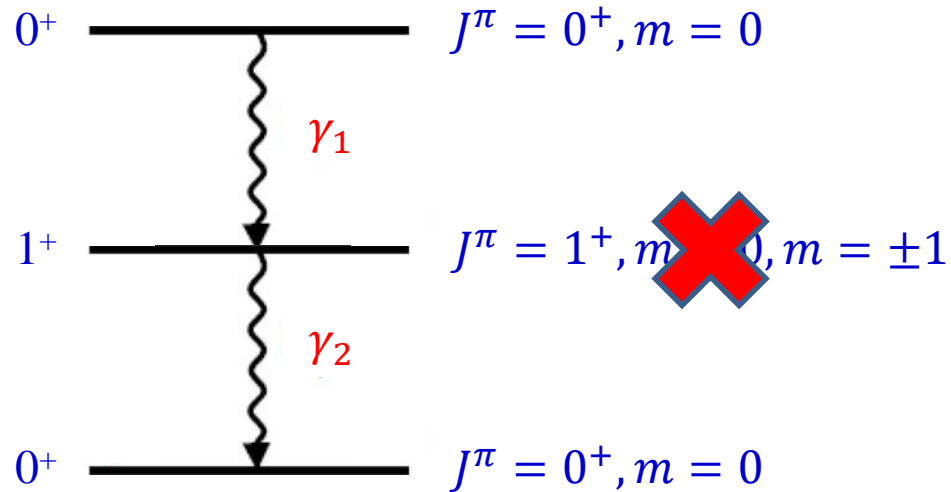

Hence, for γ_2 we only see the $m=\pm 1$ to $m=0$ part of the distribution i.e. we see that the intensity measured as a function of angle (relative to γ_1) follows a $1 + \cos^2\theta$ distribution.

General formula

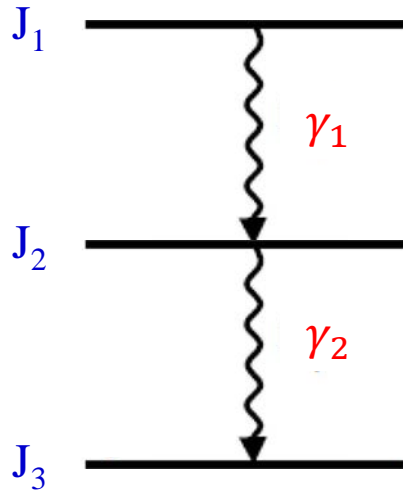

In general, the γ -ray intensity varies as:

$$W(\theta) = \sum_{k \text{ even}} A_k(\gamma_1) A_k(\gamma_2) Q_k(\gamma_1) Q_k(\gamma_2) P_k(\cos\theta)$$

where

θ is the relative angle between the two γ -rays

Q_k accounts for the fact that we do not have point detectors

A_k depends on the details of the transition and the spins of the level

$$P_0 = 1 \quad P_2 = \frac{1}{2}(3 \cdot \cos^2(\theta) - 1) \quad P_4 = \frac{1}{8}(35\cos^4(\theta) - 30\cos^2(\theta) + 3)$$

$$W(\theta) = 1 + a_2 \cos^2\theta + a_4 \cos^4\theta$$

$I_1(\ell_1)$	$I_2(\ell_2)$	I_3	a_2	a_4
0 (1)	1 (1)	0	1	0
1 (1)	1 (1)	0	-1/3	0
1 (2)	1 (1)	0	-1/3	0
2 (1)	1 (1)	0	1/13	0
3 (2)	1 (1)	0	-3/29	0
0 (2)	2 (2)	0	-3	4
1 (1)	2 (2)	0	-1/3	0
2 (1)	2 (2)	0	3/7	0
2 (2)	2 (2)	0	-15/13	16/13
3 (2)	2 (2)	0	-3/29	0
4 (2)	2 (2)	0	1/8	1/24

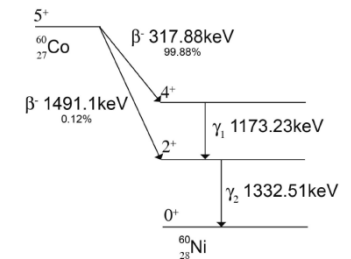
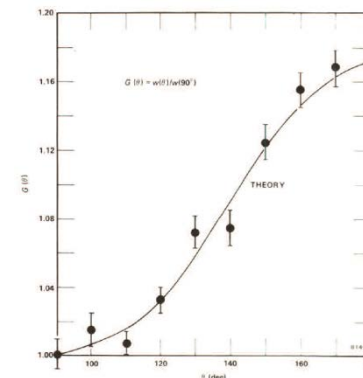

R.D. Evans, *The Atomic Nucleus*

General formula

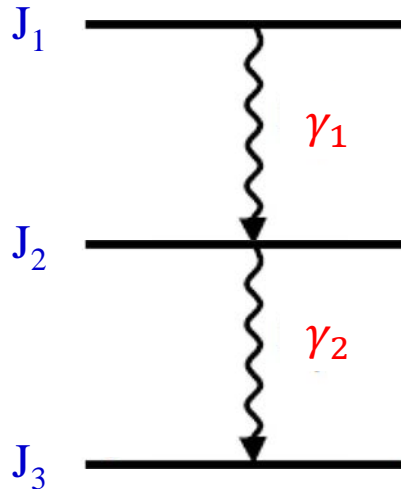

In general, the γ -ray intensity varies as:

$$W(\theta) = \sum_{k \text{ even}} A_k(\gamma_1) A_k(\gamma_2) Q_k(\gamma_1) Q_k(\gamma_2) P_k(\cos\theta)$$

where

θ is the relative angle between the two γ -rays

Q_k accounts for the fact that we do not have point detectors

A_k depends on the details of the transition and the spins of the level

$$P_0 = 1 \quad P_2 = \frac{1}{2}(3 \cdot \cos^2(\theta) - 1) \quad P_4 = \frac{1}{8}(35 \cos^4(\theta) - 30 \cos^2(\theta) + 3)$$

$$A_k(\gamma_1) = \frac{F_k(J_2 J_1 \ell, \ell) - 2 \cdot \delta \cdot F_k(J_2 J_1 \ell, \ell + 1) + \delta^2 \cdot F_k(J_2 J_1 \ell + 1, \ell + 1)}{1 + \delta^2}$$

$$A_k(\gamma_2) = \frac{F_k(J_2 J_3 L, L) - 2 \cdot \delta \cdot F_k(J_2 J_3 L, L + 1) + \delta^2 \cdot F_k(J_2 J_3 L + 1, L + 1)}{1 + \delta^2}$$

Ferentz-Rosenzweig coefficients

$$F_k(LL'I_1I_2) = (-1)^{I_1+I_2+1} \sqrt{2k+1} \sqrt{2L+1} \sqrt{2L'+1} \sqrt{2I_2+1} \begin{pmatrix} L & L' & k \\ 1 & -1 & 0 \end{pmatrix} \begin{Bmatrix} L & L' & k \\ I_1 & I_1 & I_2 \end{Bmatrix}$$

A special case:

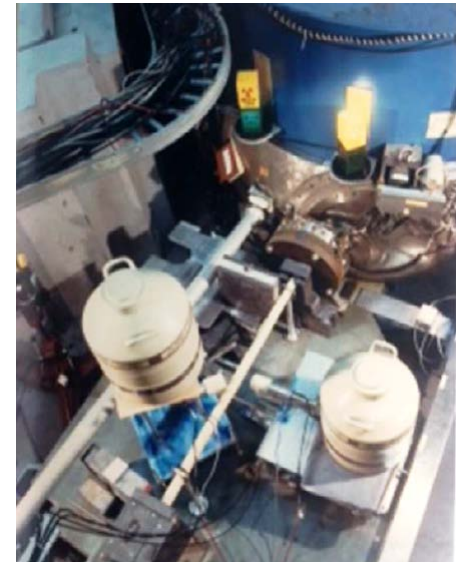
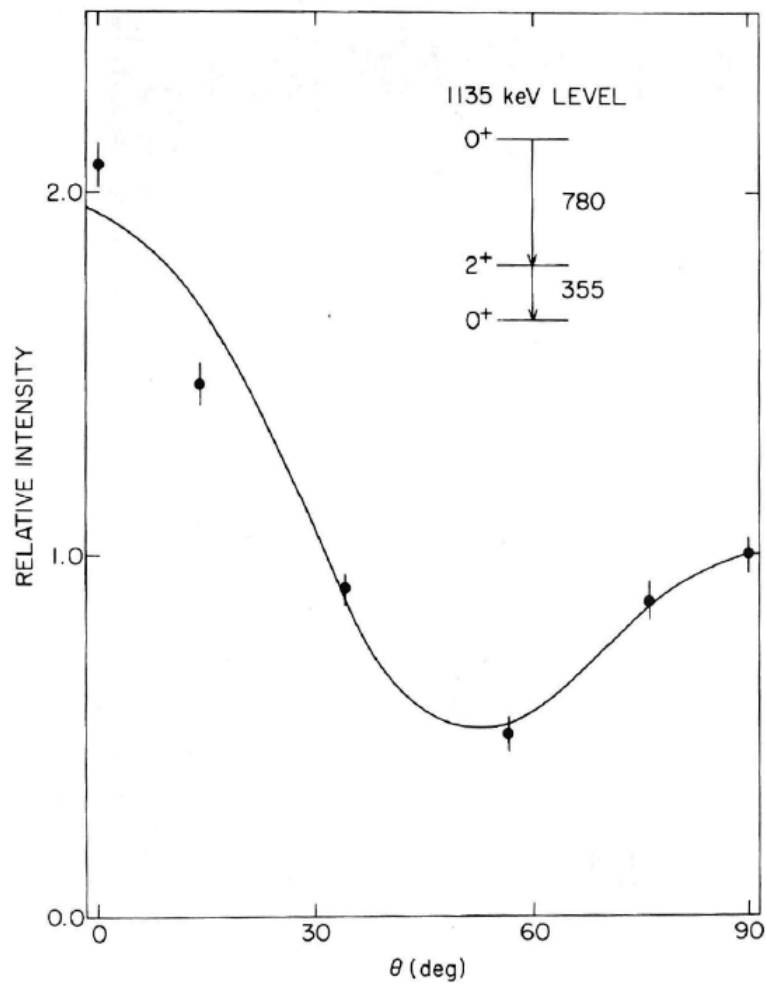
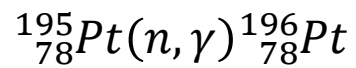

Angular correlations with arrays

Many arrays are designed symmetrically, so the range of possible angles is reduced.

Therefore one measures a Directional Correlation from Oriented Nuclei (DCO ratio)

In the simplest case, if you have an array with detectors at 35° and 90° .

Gate on 90° detector, measure coincident intensities in

- other 90° detectors
- 35° detectors

Take the ratio and compare with calculations ... can usually separate quadrupoles from dipoles but cannot measure mixing ratios

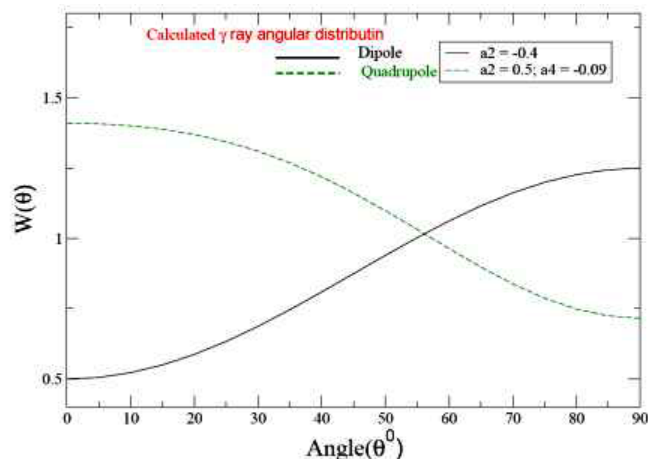

Angular correlations with arrays

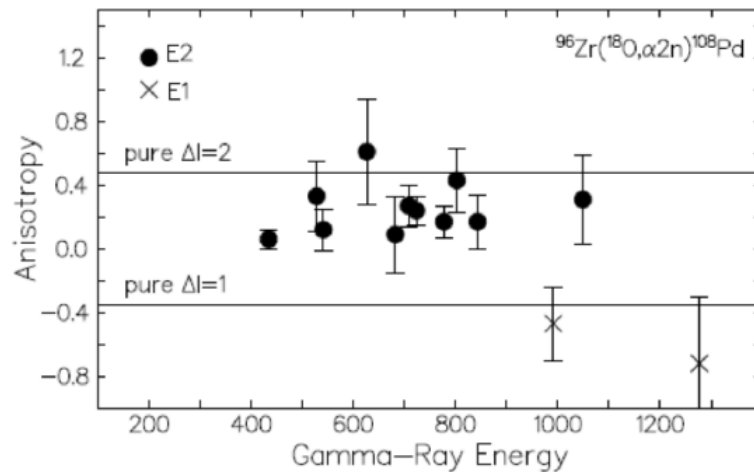
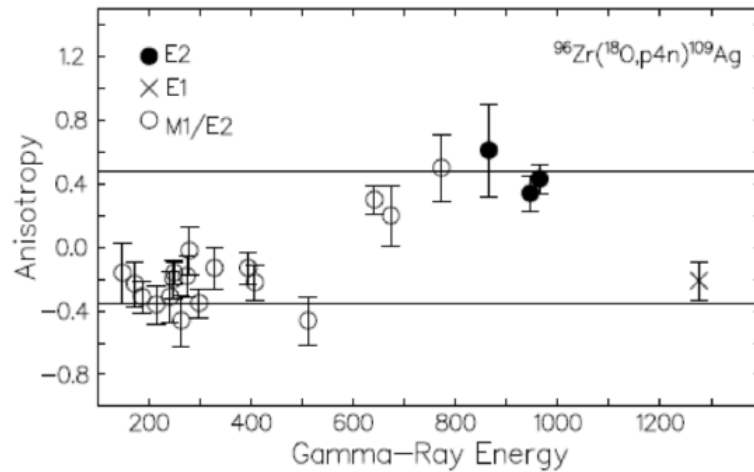

K.R.Pohl et al., Phys Rev C53 (1996) 2682

Angular distribution - fusion

In heavy-ion fusion-evaporation reactions, the compound nuclei have their spin aligned in a plane perpendicular to the beam axis:

$$\vec{\ell} = \vec{r} \times \vec{p}$$

Depending on the number and type of particles 'boiled off' before a γ -ray is emitted, transitions are emitted from **oriented** nuclei and therefore their intensity shows an angular dependence.

$$W(\theta) = A_0 \left(1 + \frac{A_2}{A_0} \cdot B_2 \cdot Q_2 \cdot P_2(\cos\theta) + \frac{A_4}{A_0} \cdot B_4 \cdot Q_4 \cdot P_4(\cos\theta) \right)$$

where A_k , Q_k and P_k are as before and B_k contains information about the alignment of the state

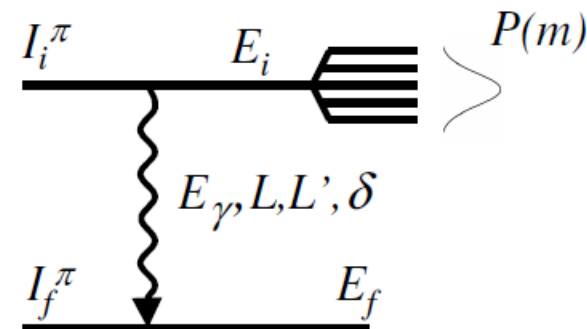

$$B_k(I_i) = \sqrt{2I_i + 1} \sum_{m=-I}^{+I} (-1)^{I_i-m} \langle I_i m I_i - m | k 0 \rangle P(m)$$

$$P(m) = \frac{\exp\left(-\frac{m^2}{2\sigma^2}\right)}{\sum_{m'=-I}^{+I} \exp\left(-\frac{m'^2}{2\sigma^2}\right)}$$

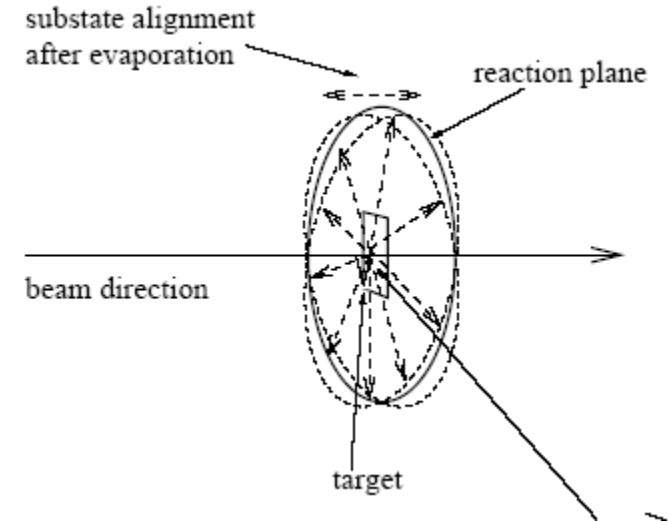

Angular distribution

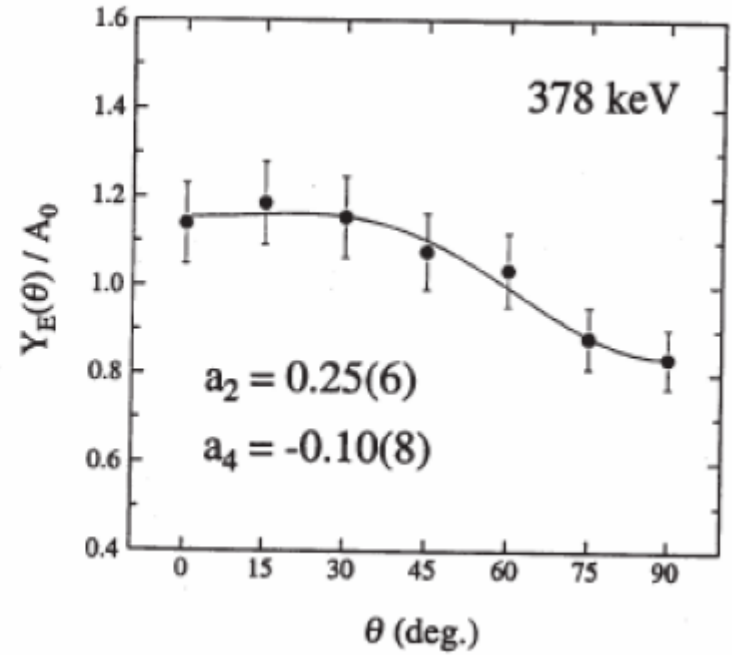
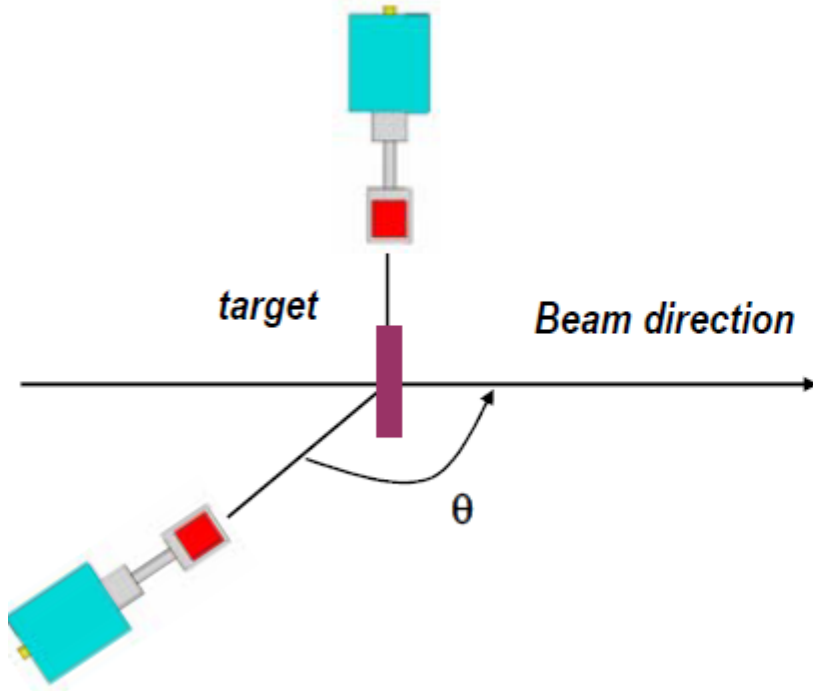

Measure: the γ -ray yield as a function of θ

Angular distribution: Coulomb excitation

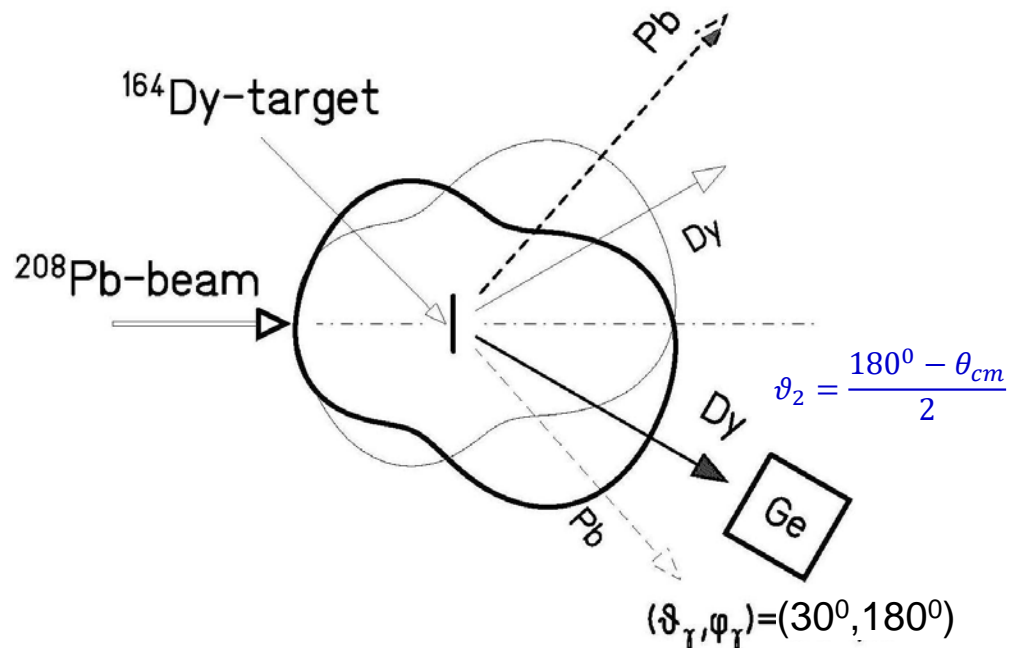
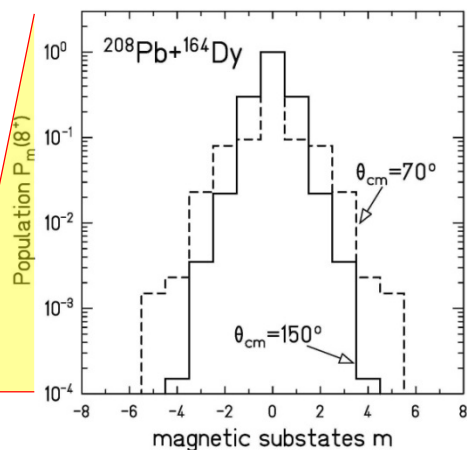
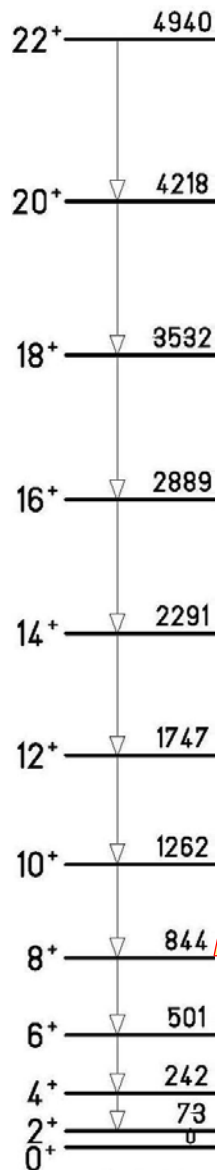

$$\frac{dW(\gamma_{N \rightarrow M})}{d\Omega_{\gamma}^{Rest}} = a_0 \cdot \left[1 + \frac{a_2}{a_0} Q_2 P_2(\cos\vartheta_{\gamma 2}) + \frac{a_4}{a_0} Q_4 P_4(\cos\vartheta_{\gamma 2}) \right]$$

$$\cos\vartheta_{\gamma 2} = \cos\vartheta_{\gamma} \cdot \cos\vartheta_2 + \sin\vartheta_{\gamma} \cdot \sin\vartheta_2 \cdot \cos(\varphi_{\gamma} - \varphi_2)$$

$$a_0 = \frac{1}{1 + \alpha_T(I \rightarrow I - 2)} \frac{1}{4\pi} P_I$$

$$\frac{a_2}{a_0} = \frac{5 I + 1}{7 2I - 1}$$

(for $m=0$ and stretched E2)

$$\frac{a_4}{a_0} = -\frac{3 (I + 1) \cdot (I + 2)}{7 (2I - 3) \cdot (2I - 1)}$$

(for $m=0$ and stretched E2)

Linear polarization

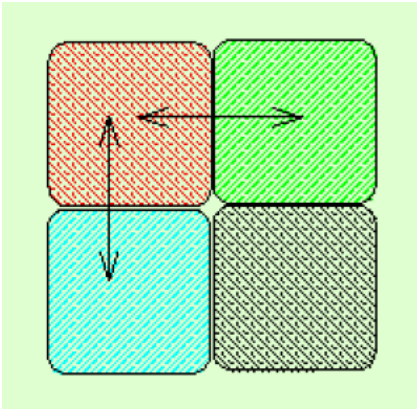

A segmented detector can be used to measure the **linear polarization** which can be used to distinguish between magnetic (M) and electric (E) character of radiation of the same multipolarity.

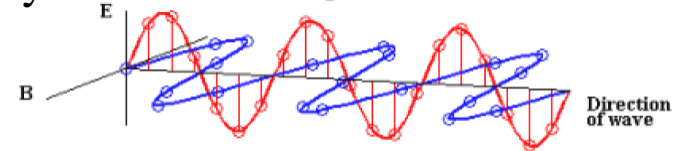

The **Compton scattering cross section** is larger in the direction perpendicular to the electrical field vector of the radiation.

Define experimental asymmetry as:
$$A = \frac{N_{90} - N_0}{N_{90} + N_0}$$

where N_{90} and N_0 are the intensities of scattered photons perpendicular and parallel to the reaction plane.

The experimental linear polarization $P=A/Q$ where Q is the polarization sensitivity of the detector

$Q \sim 13\%$ at 1 MeV

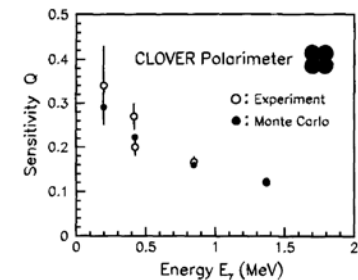

Linear polarization

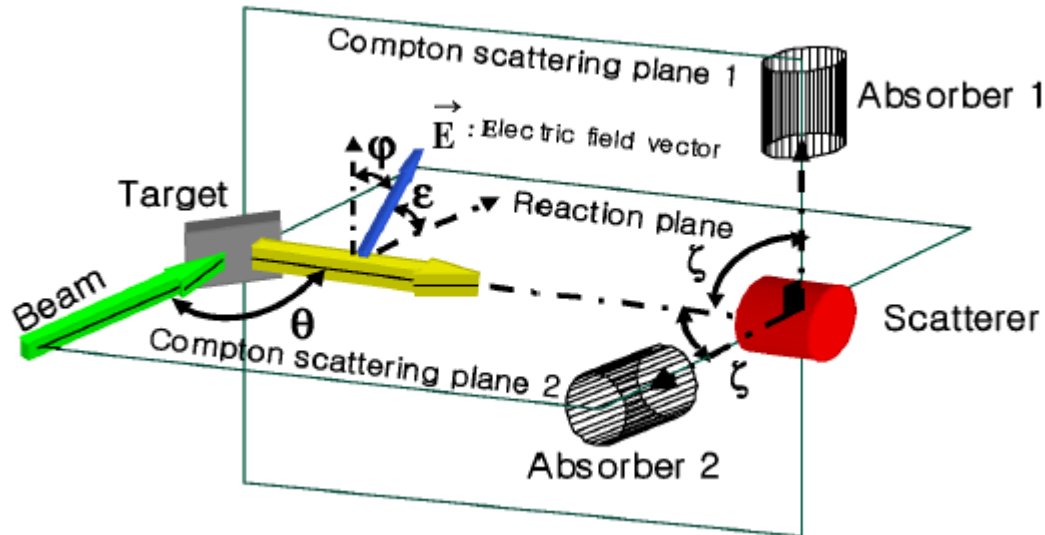

Klein-Nishina formula:

$$\frac{d\sigma_c}{d\Omega} = \frac{r_0^2}{2} \left(\frac{E_{\gamma'}}{E_\gamma} \right)^2 \cdot \left\{ \frac{E_\gamma}{E_{\gamma'}} + \frac{E_{\gamma'}}{E_\gamma} - 2 \sin^2 \theta \cdot \cos^2 \phi \right\}$$

Maximum polarization at $\theta=90^\circ$

Linear polarization

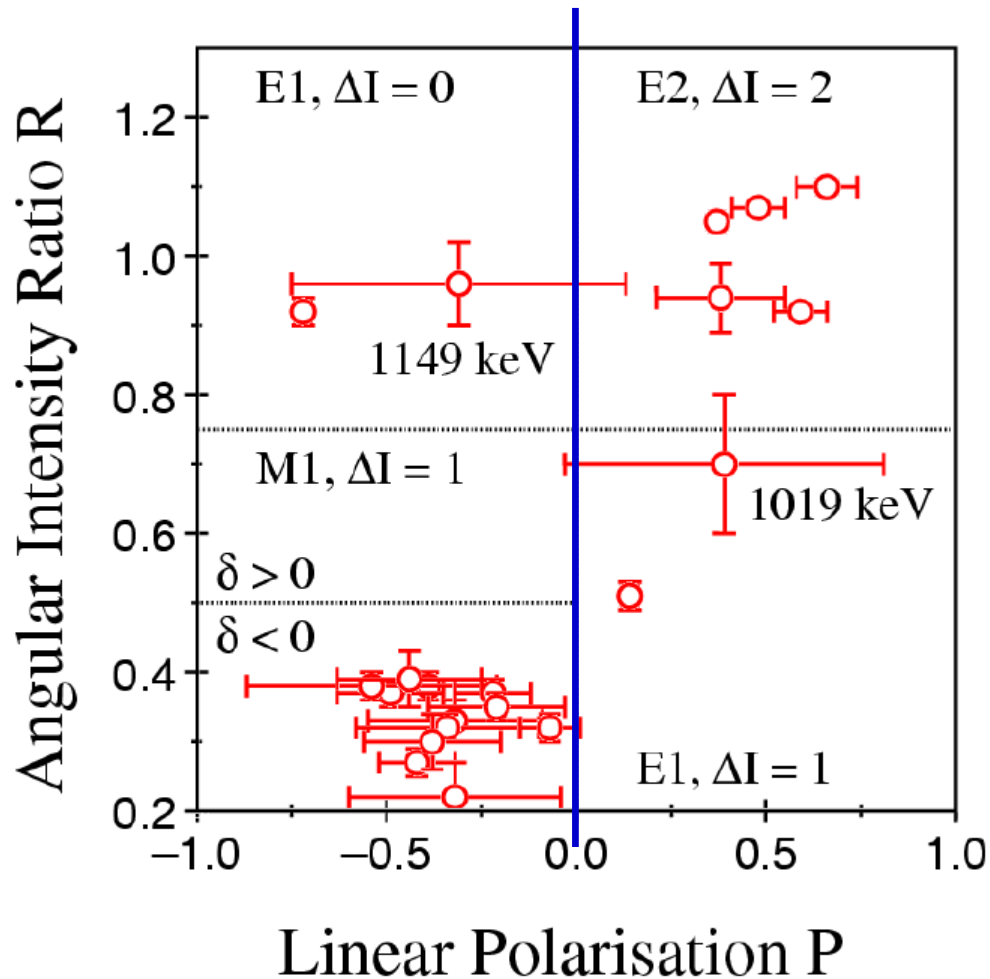

Plot P against the angular distribution information to uniquely define the multipolarity.

Data from Eurogam

Laser Compton backscattering

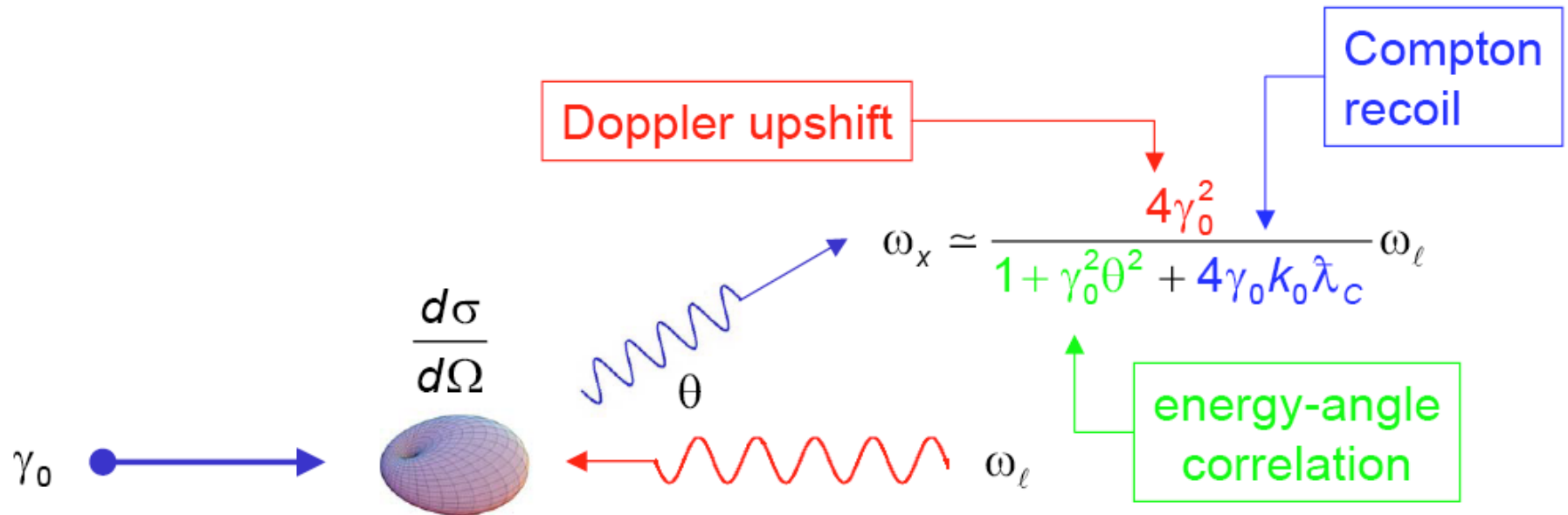
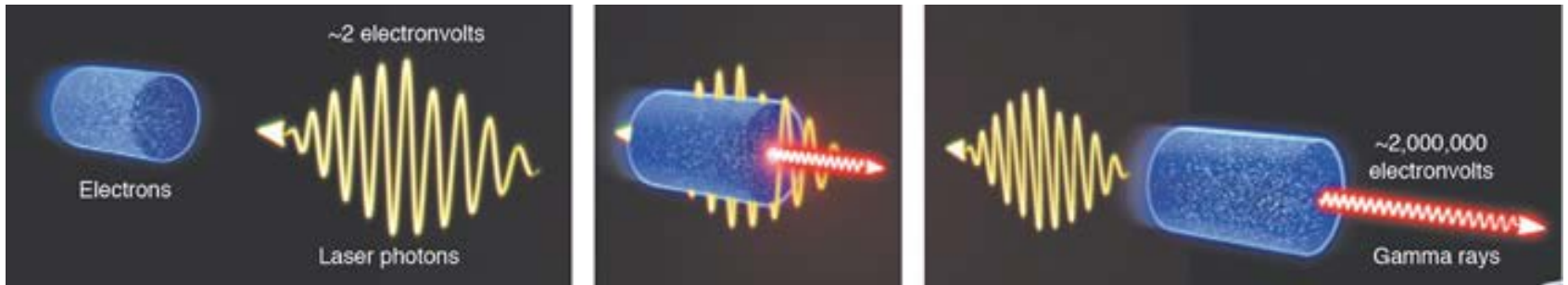

Energy – momentum conservation yields $\sim 4\gamma^2$ Doppler upshift
 Thomsons scattering cross section is very small ($6 \cdot 10^{-25} \text{ cm}^2$)
 ⇒ High photon and electron density are required

Efficiency versus resolution

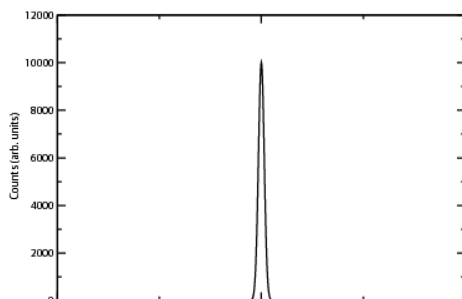
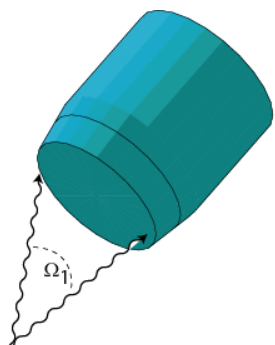

With a source at rest, the intrinsic resolution of the detector can be reached; efficiency decreases with the increasing detector-source distance.

With a moving source also the effective energy resolution depends on the detector-source distance (Doppler effect)

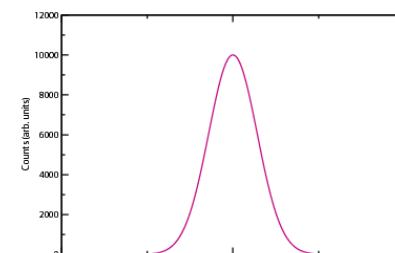
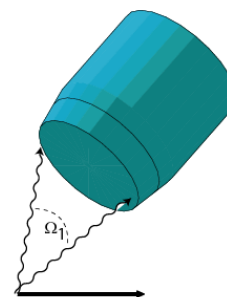

Small d
Large d



Large Ω
Small Ω



High ϵ
Low ϵ



Poor FWHM
Good FWHM

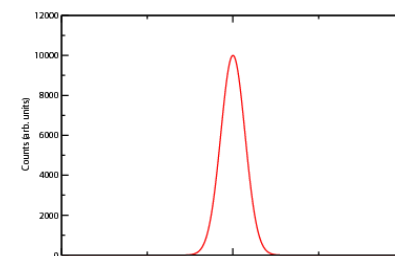
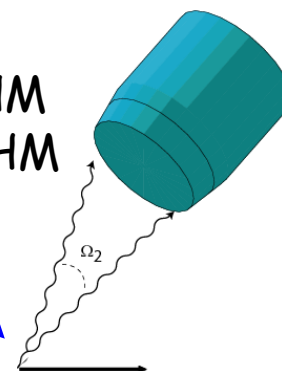

Energy resolution

The major factors affecting the final energy resolution (FWHM) at a particular energy are as follows:

$$\Delta E_{\gamma}^{final} = (\Delta E_{Int}^2 + \Delta\theta_{det}^2 + \Delta\theta_N^2 + \Delta v^2)^{1/2}$$

ΔE_{Int} – The intrinsic resolution of the detector system.
It includes contributions from the detector itself and the electronic components used to process the signal.

$\Delta\theta_{det}$ – The Doppler broadening arising from the opening angle of the detectors

$\Delta\theta_N$ – The Doppler broadening arising from the angular spread of the recoils in the target

Δv – The Doppler broadening arising from the velocity (energy) variation of the excited nucleus

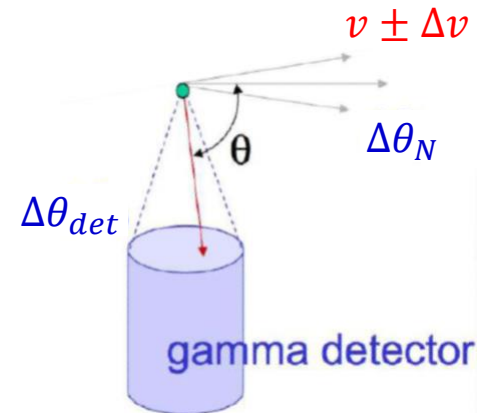

Special relativity

Lorentz transformation:

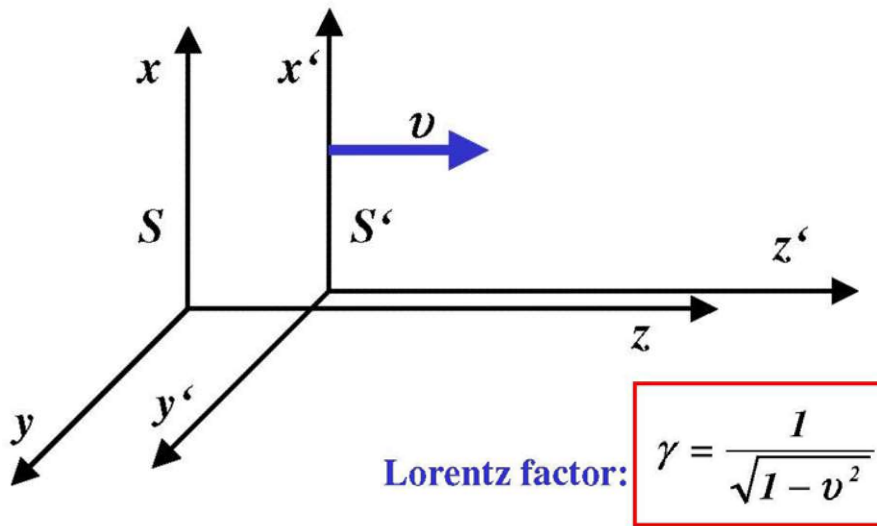

□ Consider the space-time point

- in a given frame S: (t, x, y, z)
- and in a (moving) frame S': (t', x', y', z')

1) S' moves with a constant velocity v along z-axis

Space-time Lorentz transformation $S \leftrightarrow S'$:

$S \Rightarrow S'$	$S' \Rightarrow S$
$x' = x$	$x = x'$
$y' = y$	$y = y'$
$z' = \gamma(z - vt)$	$z = \gamma(z' + vt)$
$t' = \gamma(t - vz)$	$t = \gamma(t' + vz)$

Note: units $c=1$

$$t' = \gamma\left(t - \frac{v}{c^2}z\right)$$

$$t = \gamma\left(t' + \frac{v}{c^2}z\right)$$

$$v_z = |\vec{v}| = v$$

□ Consider the 4-momentum:

- in a given frame S: $p \equiv (E, \vec{p}) = (E, p_x, p_y, p_z)$
- in the (moving) frame S': $p' \equiv (E', \vec{p}') = (E', p'_x, p'_y, p'_z)$

Lorentz transformation
for 4-momentum $S \leftrightarrow S'$:

$$\begin{aligned} p'_x &= p_x, & p'_y &= p_y \\ p'_z &= \gamma(p_z - vE) \\ E' &= \gamma(E - vp_z) \end{aligned}$$

Lorentz transformation

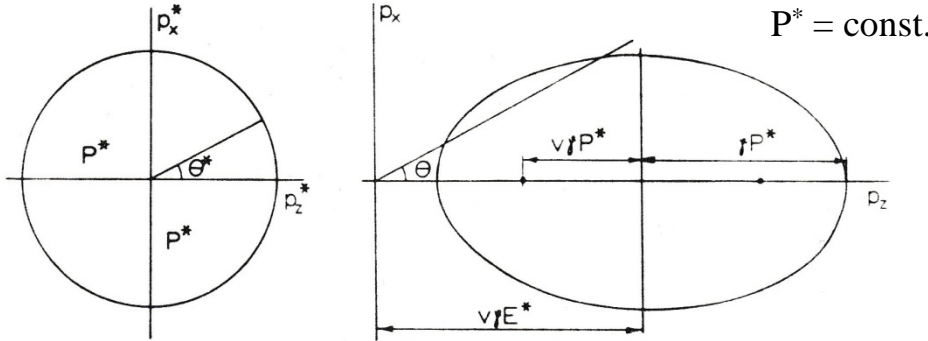

rest system

laboratory system

total energy:

$$E^* = \gamma \cdot E - \gamma \cdot v \cdot P \cdot \cos\theta$$

with

$$E = \sqrt{(mc^2)^2 + (Pc)^2}$$

E^* , P^* total energy and momentum in the rest system

E , P total energy and momentum in the laboratory system

Doppler formula for zero-mass particle (photon):

$$E=Pc$$

$$E^* = \gamma \cdot E - \gamma \cdot \beta \cdot E \cdot \cos\theta$$

$$E^* = \gamma \cdot E(1 - \beta \cdot \cos\theta)$$

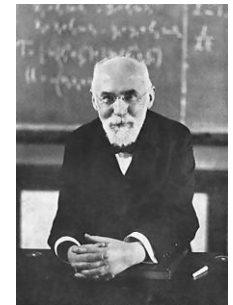

Hendrik Lorentz

Doppler effect

$$\frac{E_{\gamma 0}}{E_{\gamma}} = \frac{1 - \beta \cdot \cos \vartheta_{\gamma}^{lab}}{\sqrt{1 - \beta^2}}$$

for $\vartheta_p \cong 0^{\circ}$

$$\frac{d\Omega_{rest}}{d\Omega_{lab}} = \left(\frac{E_{\gamma}}{E_{\gamma 0}} \right)^2$$

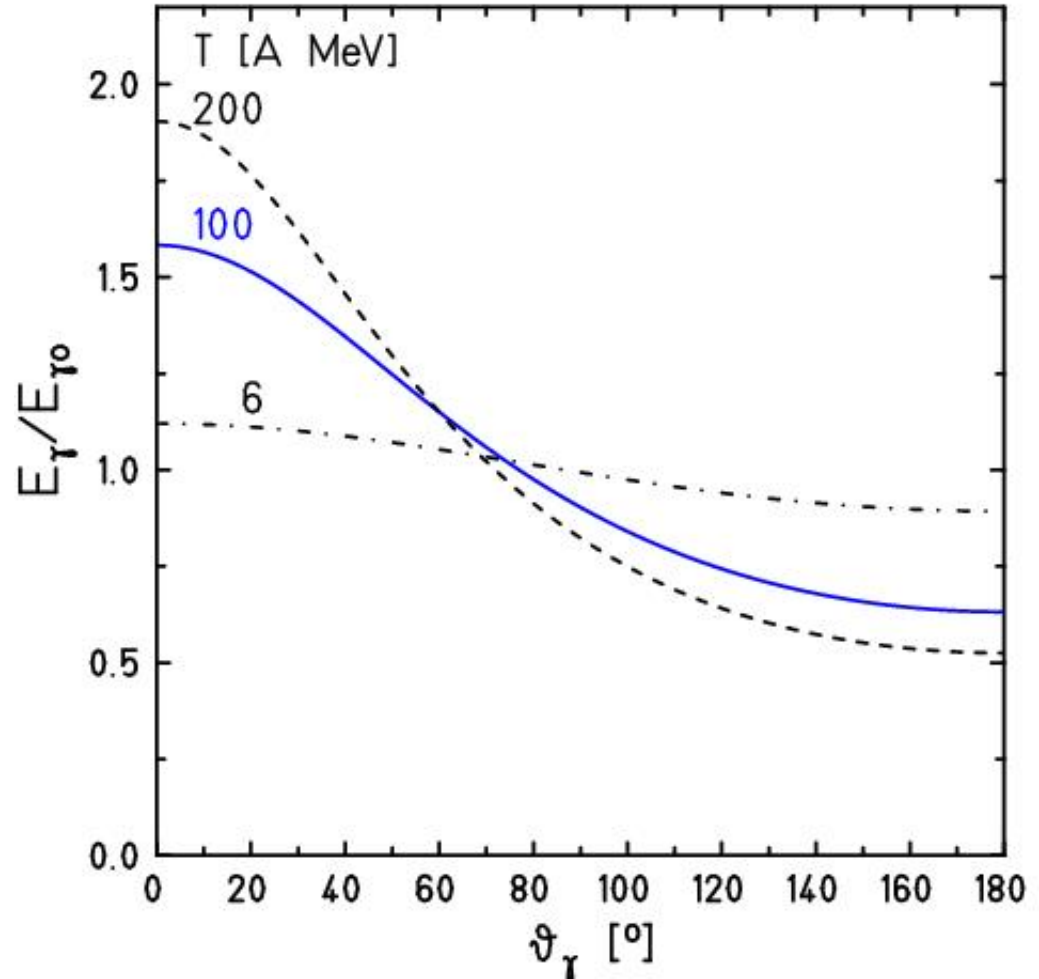

Doppler broadening and position resolution

$$E_{\gamma 0} = E_{\gamma} \frac{1 - \beta \cdot \cos \vartheta_{\gamma}}{\sqrt{1 - \beta^2}} \quad (\beta, \vartheta_p = 0^{\circ}, \vartheta_{\gamma} \text{ and } E_{\gamma} \text{ in lab-frame})$$

$$\left(\frac{\Delta E_{\gamma 0}}{E_{\gamma 0}}\right)^2 = \left(\frac{\beta \cdot \sin \vartheta_{\gamma}}{1 - \beta \cdot \cos \vartheta_{\gamma}}\right)^2 (\Delta \vartheta_{\gamma})^2 + \left(\frac{\beta - \cos \vartheta_{\gamma}}{(1 - \beta^2) \cdot (1 - \beta \cdot \cos \vartheta_{\gamma})}\right)^2 (\Delta \beta)^2 + \left(\frac{1}{E_{\gamma}}\right)^2 (\Delta E_{\gamma})^2$$

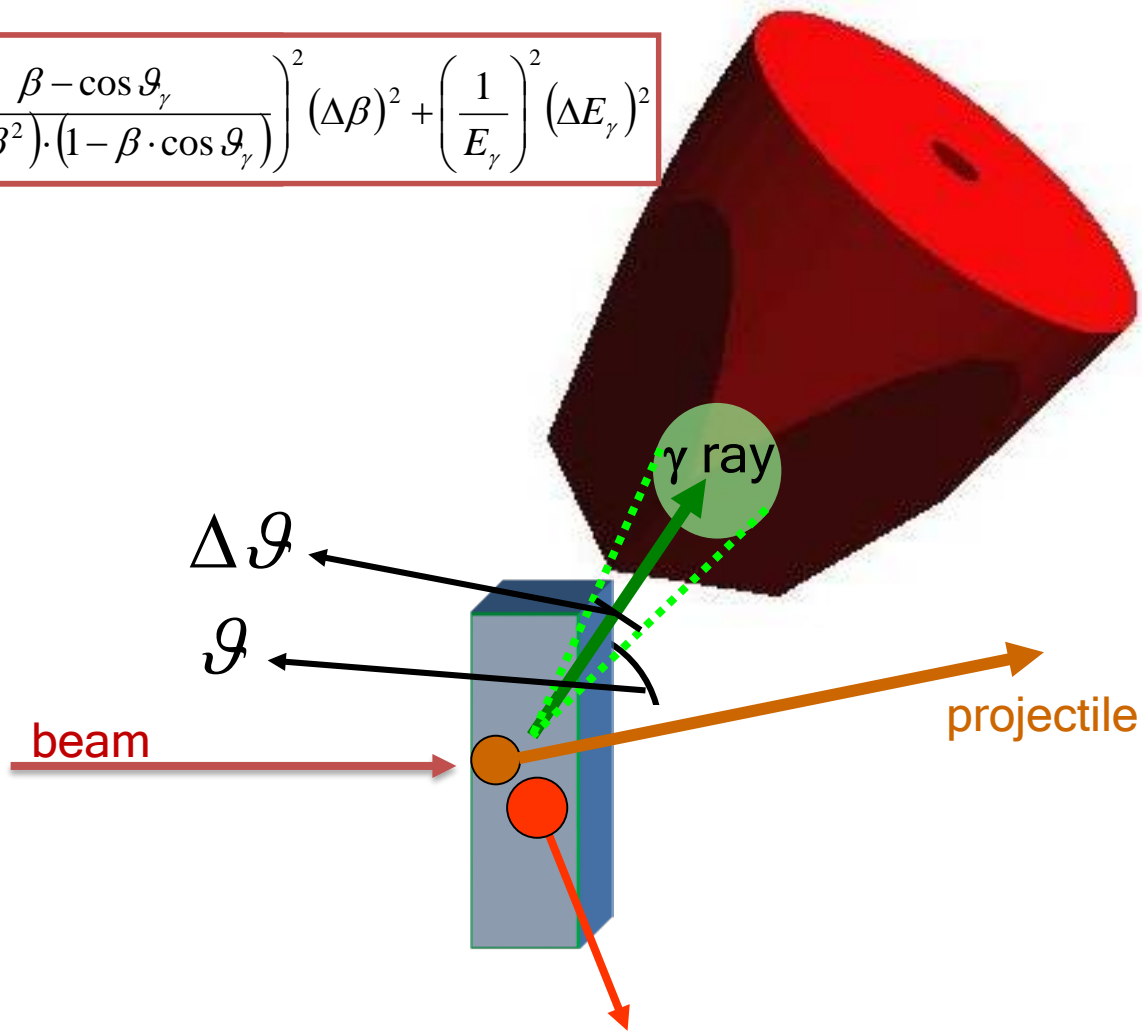
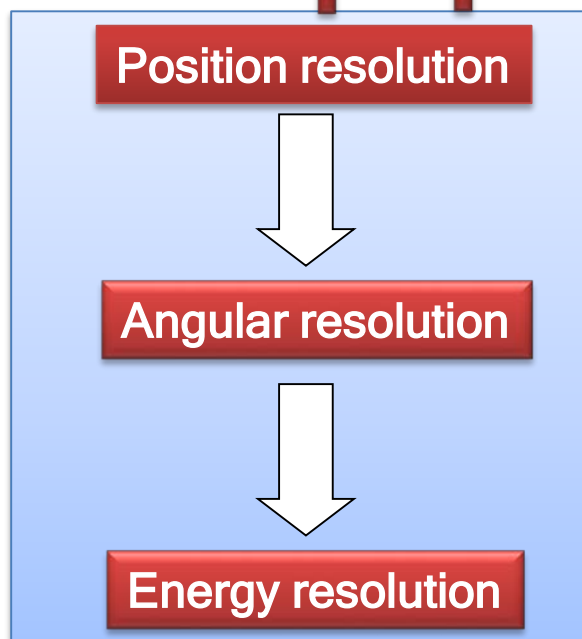

Doppler broadening (opening angle of detector)

$$\frac{\Delta E_{\gamma 0}}{E_{\gamma 0}} = \frac{\beta \cdot \sin \vartheta_{\gamma}}{1 - \beta \cdot \cos \vartheta_{\gamma}} \cdot \Delta \vartheta_{\gamma}$$

for $\vartheta_p \cong 0^{\circ}$

with

$$\Delta \vartheta_{\gamma} = 0.622 \cdot \arctan \frac{d[\text{mm}]}{R[\text{mm}] + 30[\text{mm}]}$$

$$R = 700[\text{mm}]$$

$$d = 59[\text{mm}]$$

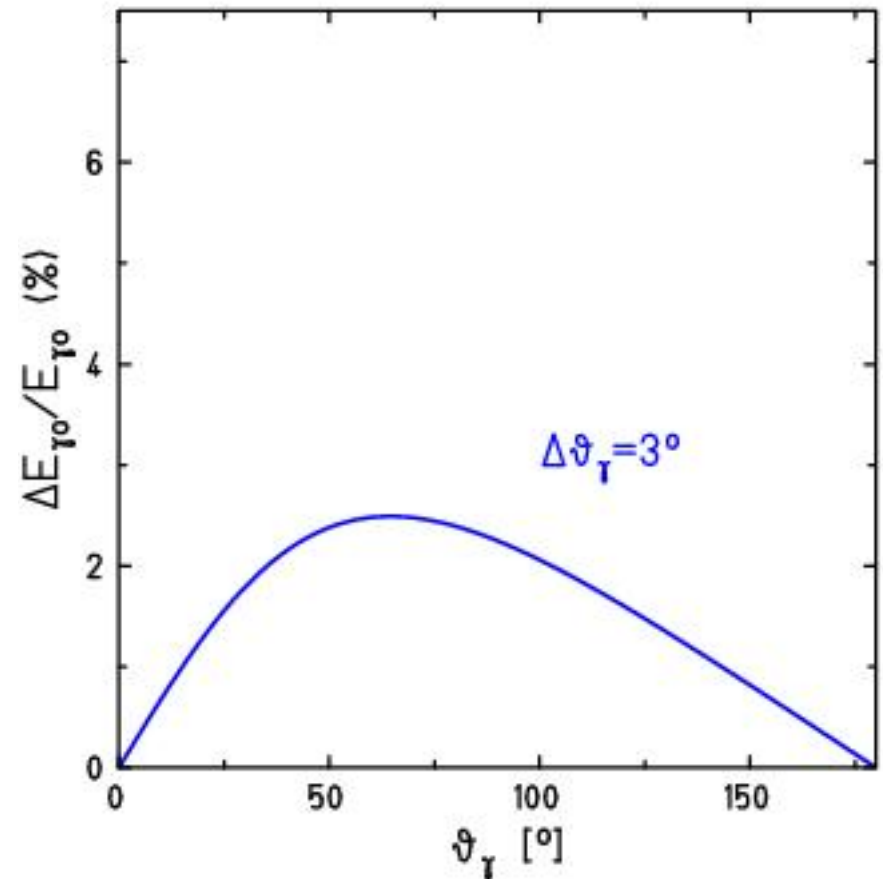

Doppler broadening (velocity variation)

$$\frac{\Delta E_{\gamma 0}}{E_{\gamma 0}} = \frac{\beta - \cos \vartheta_{\gamma}}{(1 - \beta^2) \cdot (1 - \beta \cdot \cos \vartheta_{\gamma})} \cdot \Delta\beta$$

for $\vartheta_p \cong 0^0$

with $\Delta\beta = 6\%$

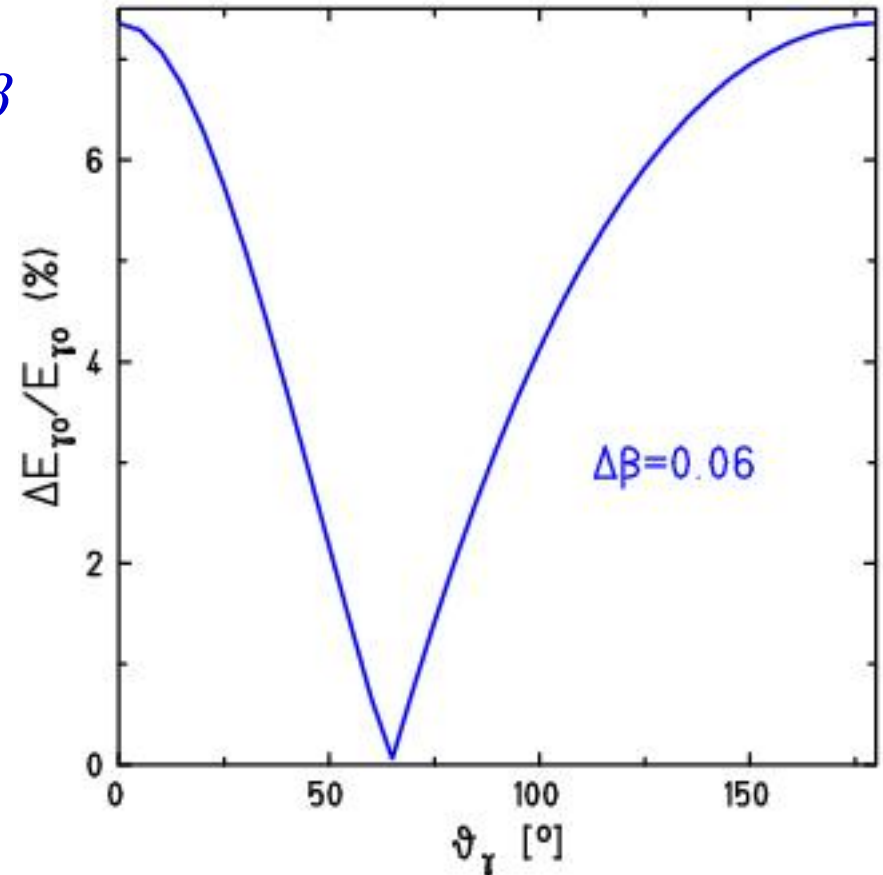

Experimental arrangement

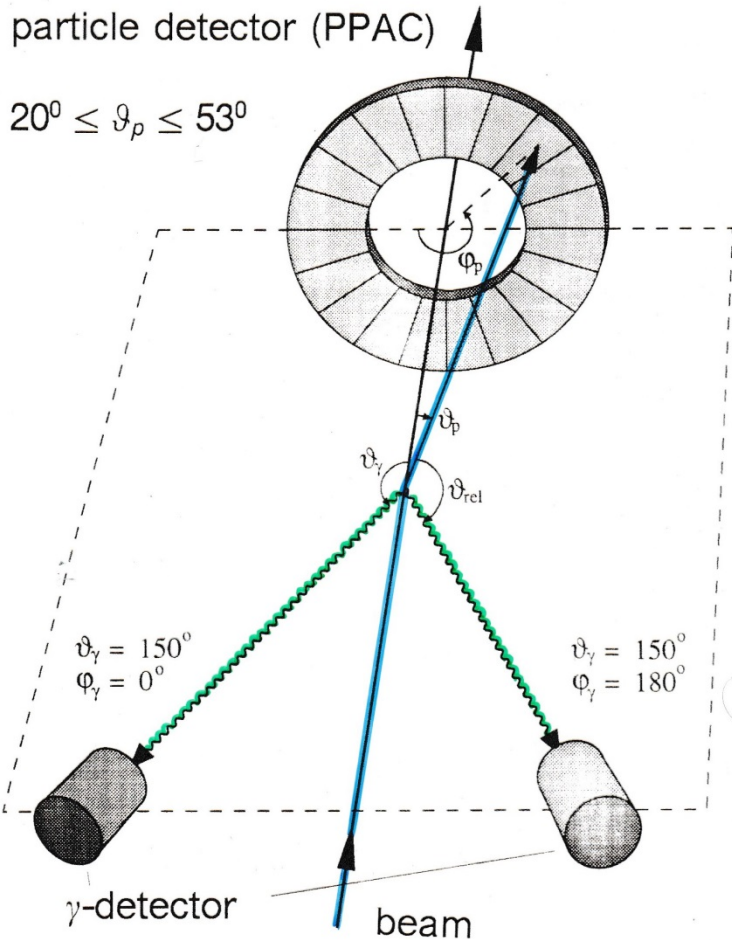

experimental problem:

Doppler broadening due to finite size of Ge-detector

$$\frac{\Delta E}{E} \sim 1\% \quad \text{for} \quad \Delta\vartheta_\gamma = 20^\circ \quad \beta_1 \cong 10\%$$

For projectile excitation:

$$E^* = \gamma \cdot E \cdot (1 - \beta_1 \cdot \cos\theta_{\gamma 1}) \quad \text{Doppler shift}$$

with

$$\cos\theta_{\gamma 1} = \cos\vartheta_1 \cos\vartheta_\gamma + \sin\vartheta_1 \sin\vartheta_\gamma \cos(\varphi_\gamma - \varphi_1)$$

$$\Delta E \cong E^* \cdot \beta_1 \cdot \sin\theta_{\gamma 1} \cdot \Delta\theta_{\gamma 1} \quad \text{Doppler broadening}$$

Inelastic heavy-ion scattering

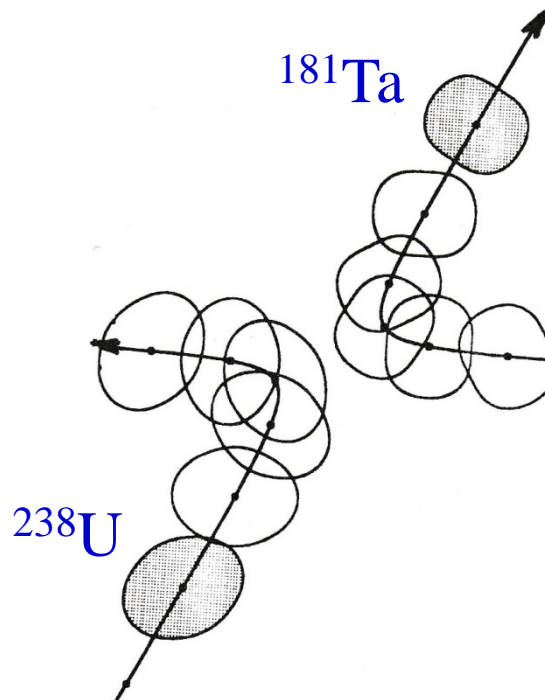
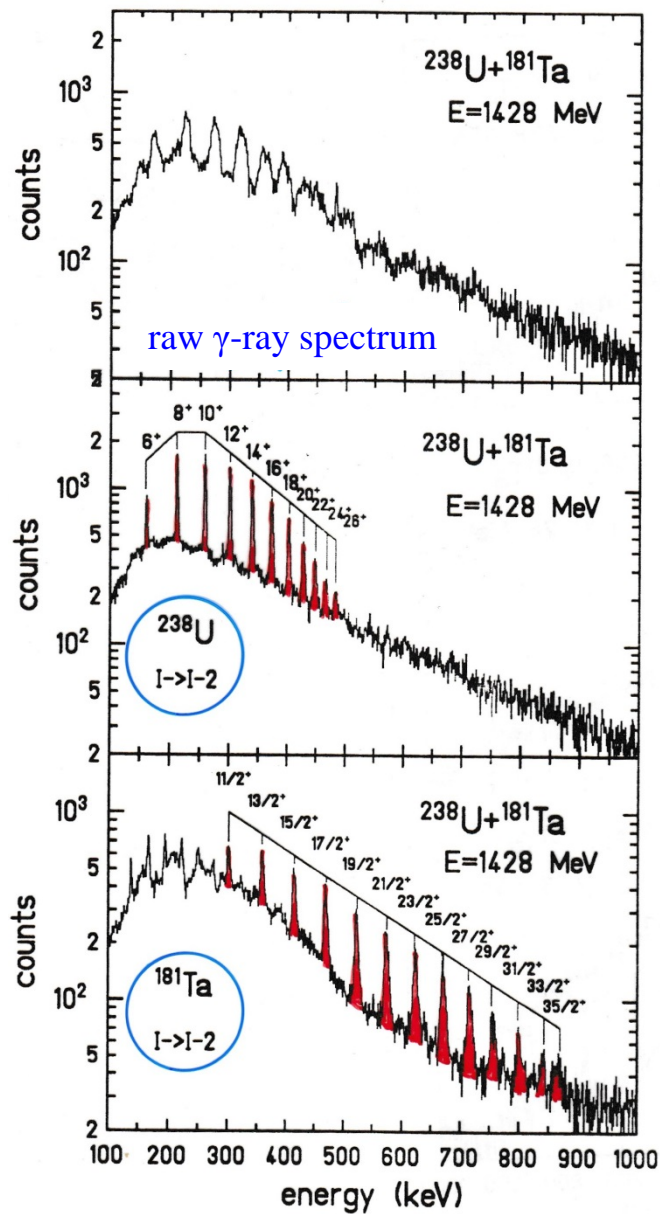

Lorentz transformation

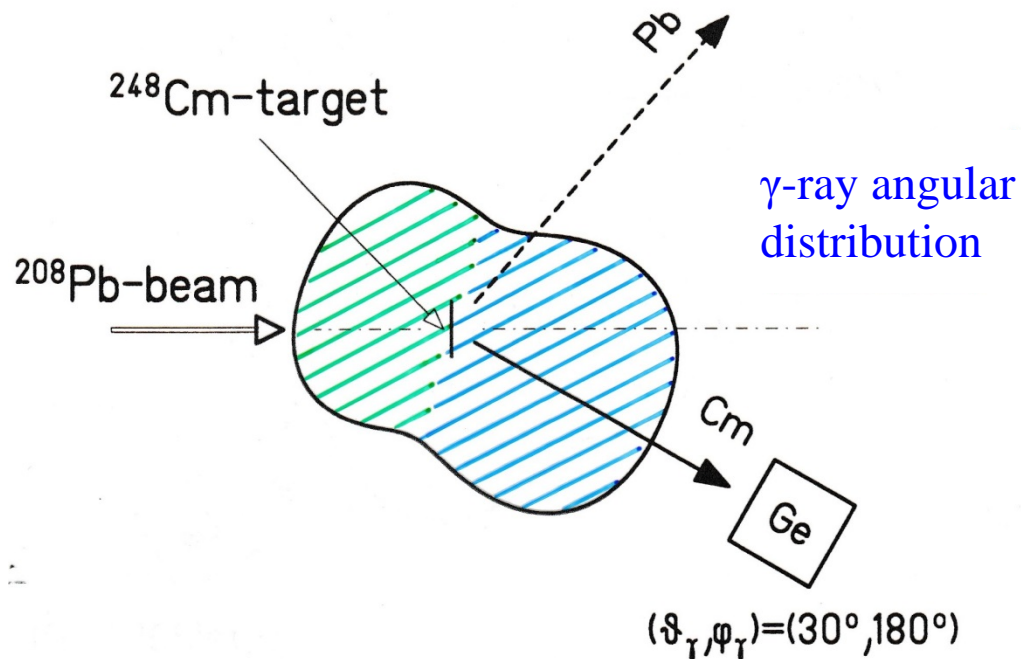

Contraction of the solid angle element in the laboratory system

$$\frac{d\Omega}{d\Omega^*} = \left\{ \frac{E^*}{E} \right\}^2$$

with

$$E^* = \gamma \cdot E \cdot (1 - \beta \cdot \cos\theta) \quad \text{Doppler formula}$$

Experimental arrangement (electron detection)

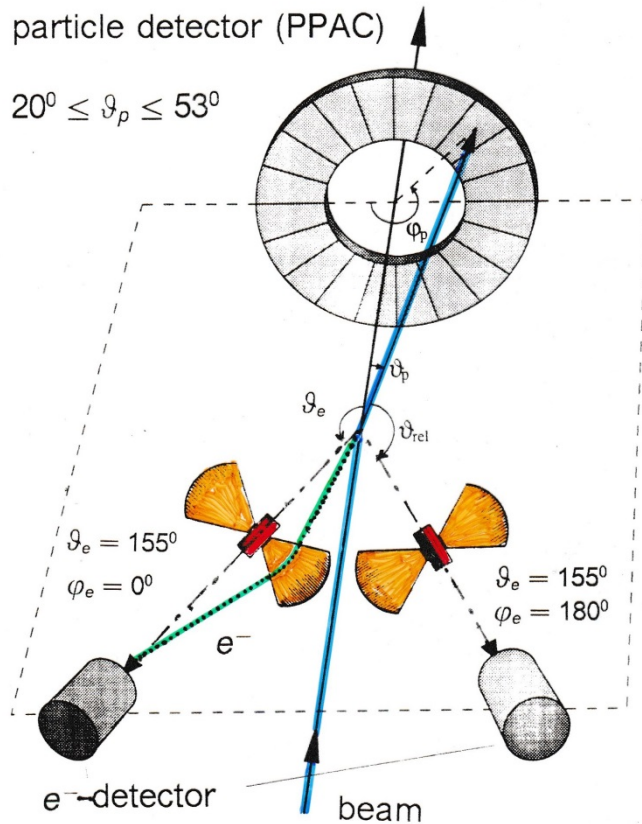

Doppler broadening

$$\Delta\vartheta_e = 20^\circ$$

target – Mini-Orange: 19 cm

Mini-Orange – Si detector: 6 cm

For projectile excitation:

$$T_e^* = \gamma \cdot T_e \cdot \left\{ 1 - \beta_1 \cdot \sqrt{1 + 2m_e c^2 / T_e \cdot \cos\theta_{e1}} \right\} + m_e c^2 \cdot (\gamma - 1)$$

with

$$\cos\theta_{e1} = \cos\vartheta_1 \cos\vartheta_e + \sin\vartheta_1 \sin\vartheta_e \cos(\varphi_e - \varphi_1)$$

Lorentz transformation

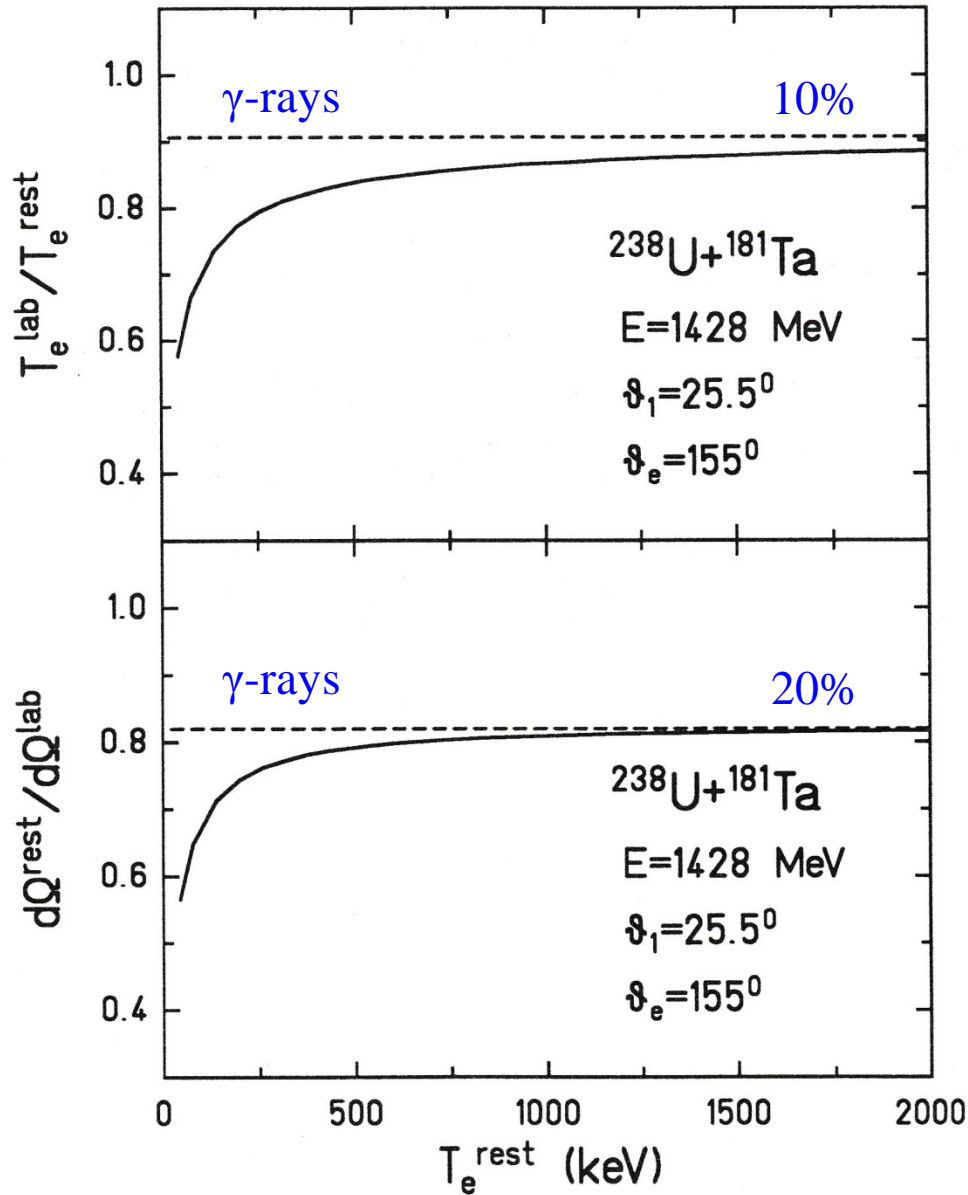

Segmented detectors

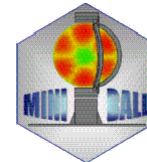
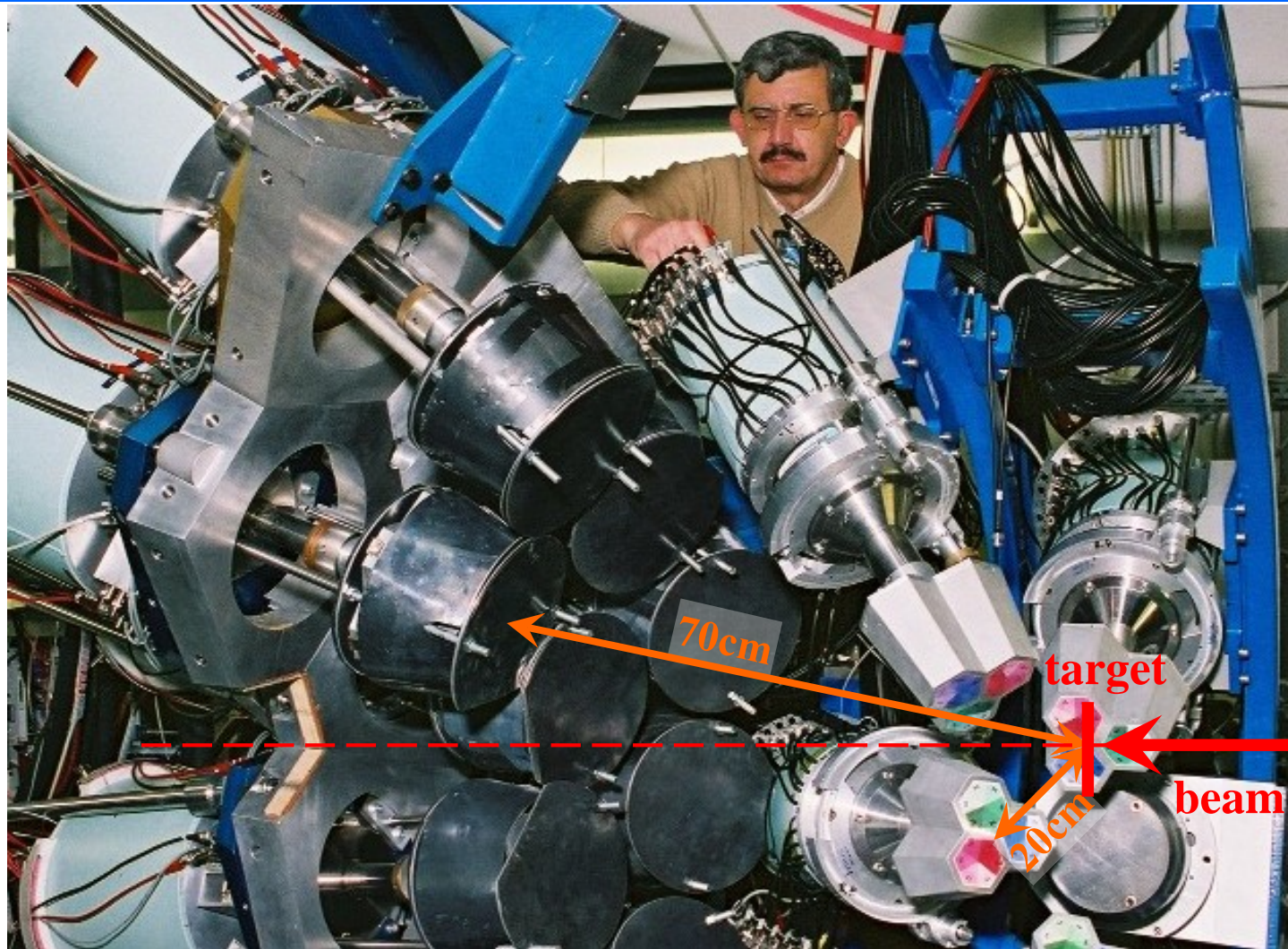

Recoil distance method

$$I_{degraded} = I \cdot e^{-d/v\tau}$$

$$I_{shifted} = (1 - e^{-d/v\tau})$$

$$\frac{I_{degraded}}{I_{degraded} + I_{shifted}} = e^{-d/v\tau}$$

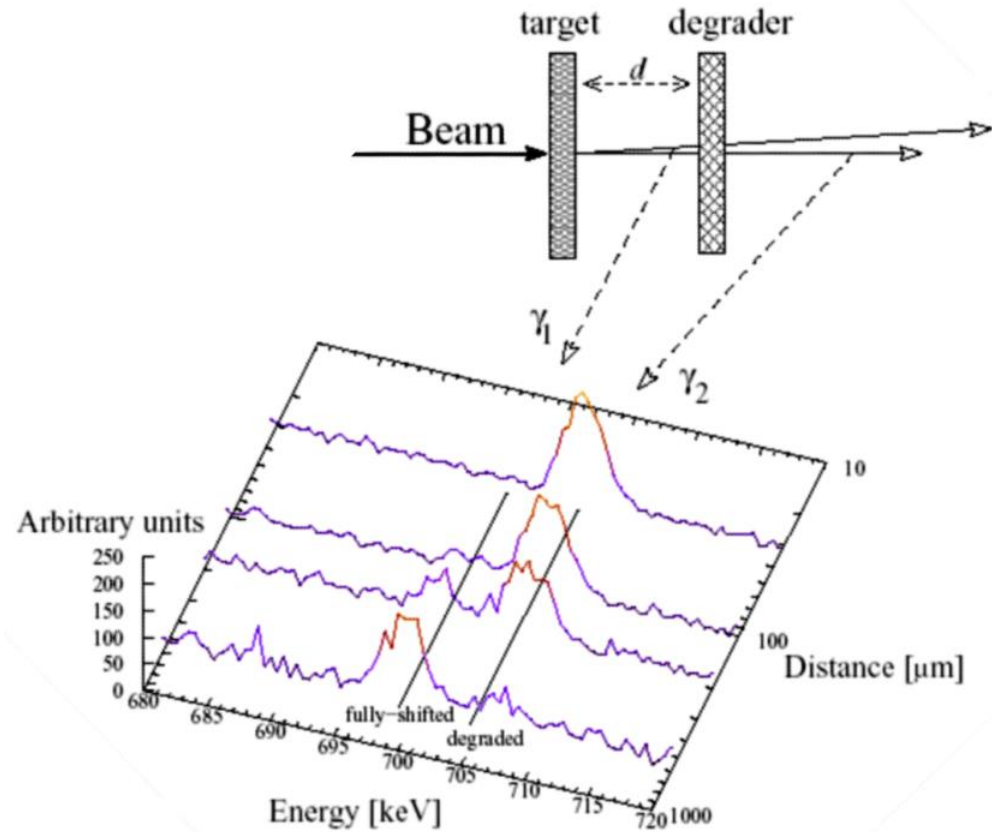
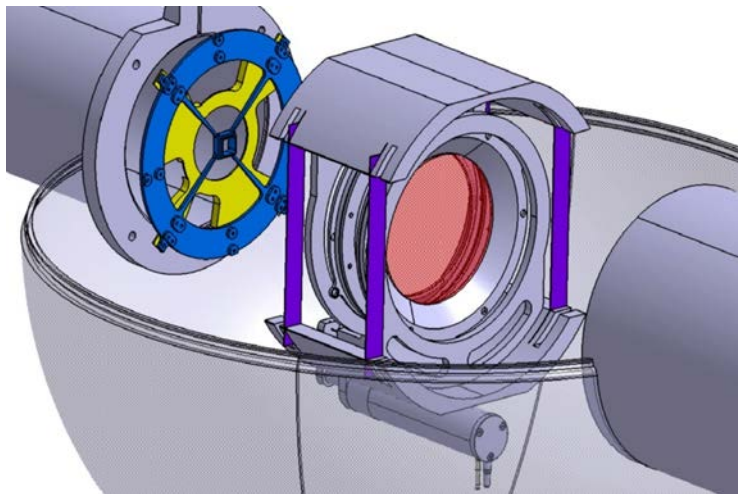

Doppler Shift Attenuation Method

