

# Semiconductor Detectors

Lecture: Hans-Jürgen Wollersheim

e-mail: [h.j.wollersheim@gsi.de](mailto:h.j.wollersheim@gsi.de)



- Semiconductor detectors have a **high density**
  - large energy loss in a short distance
  - diffusion effect is smaller than in gas detectors resulting in achievable position resolution of less than 10  $\mu\text{m}$
  
- **Low ionization energy** (few eV per e – hole pair) compared to
  - gas detectors (20 – 40 eV per e – ion pair) or
  - scintillators (400 – 1000 eV to create a photon)
  
- No internal amplification, i.e. small signal
  - with a few exceptions
  
- High cost per surface unit
  - not only Silicon itself
  - high number of readout channels
  - large power consumption, cooling

## ➤ Germanium:

- used in nuclear physics
- needs cooling due to small band gap of 0.66 eV (usually done with liquid nitrogen at 77 K)

## ➤ Silicon:

- can be operated at room temperature
- synergies with micro electronics industry

## ➤ Diamond (CVD or single crystal):

- allotrope of carbon
- large band gap (requires no depletion zone)
- very radiation hard
- disadvantage: low signal and high cost

# Compound semiconductors

- **Compound semiconductors consist of**
  - two (binary semiconductors) or
  - more than two
  
- **Depending on the column in the periodic system of elements one differentiates between**
  - IV – IV – (e.g. SiGe, SiC),
  - III – V – (e.g. GaAs)
  - II – VI compounds (CdTe, ZnSe)
  
- **important III – V compounds:**
  - **GaAs:** faster and probably more radiation resistant than Si. Drawback is less experience in industry and higher costs.
  - GaP, GaSb, InP, InAs, InSb, InAlP
  
- **important II – VI compounds:**
  - **CdTe:** high atomic number (48 + 52) hence very efficient to detect photons.
  - ZnS, ZnSe, ZnTe, CdS, Cd<sub>1-x</sub>Zn<sub>x</sub>Te, Cd<sub>1-x</sub>Zn<sub>x</sub>Se

	I	II	III	IV	V	VI	VII	VIII
1	1 H							2 He
2	3 Li	4 Be	5 B	6 C	7 N	8 O	9 F	10 Ne
3	11 Na	12 Mg	13 Al	14 Si	15 P	16 S	17 Cl	18 Ar
4	19 K	20 Ca	31 Ga	32 Ge	33 As	34 Se	35 Br	36 Kr
5	37 Rb	38 Sr	49 In	50 Sn	51 Sb	52 Te	53 I	54 Xe
6	55 Cs	56 Ba	81 Tl	82 Pb	83 Bi	84 Po	85 At	86 Rn
7	87 Fr	88 Ra	113 Uut	114 Uuq	114 Uup	115 Uuh	117 Uus	118 Uuo

# Why Silicon

- Semiconductor with moderate bandgap (1.12 eV)
- Energy to create electron/hole pair (signal quanta) = 3.6 eV  plus phonon excitation
  - (c.f. Argon gas = 15 eV)
  - high carrier yield
  - better energy resolution and high signal
    - no gain stage required
- High density and atomic number
  - higher specific energy loss
    - thinner detectors
    - reduced range of secondary particles
    - better spatial resolution
- High carrier mobility → Fast!
  - less than 30 ns to collect entire signal
- **Large experience in industry** with micro-chip technology
- High intrinsic radiation hardness

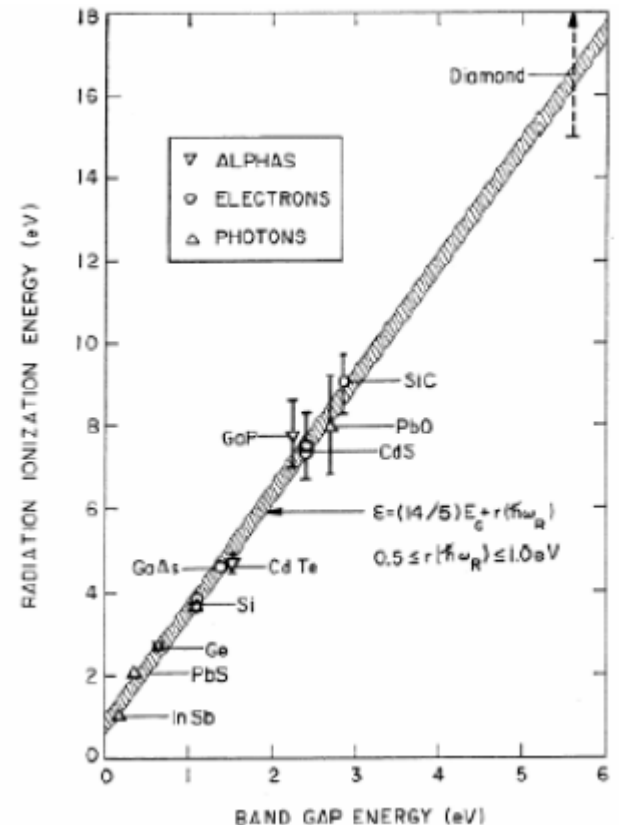

C.A. Klein, J. Applied Physics 39 (1968) 2029

# Bond model of semiconductors

Example of column IV elemental semiconductor (2-dimensional projection):

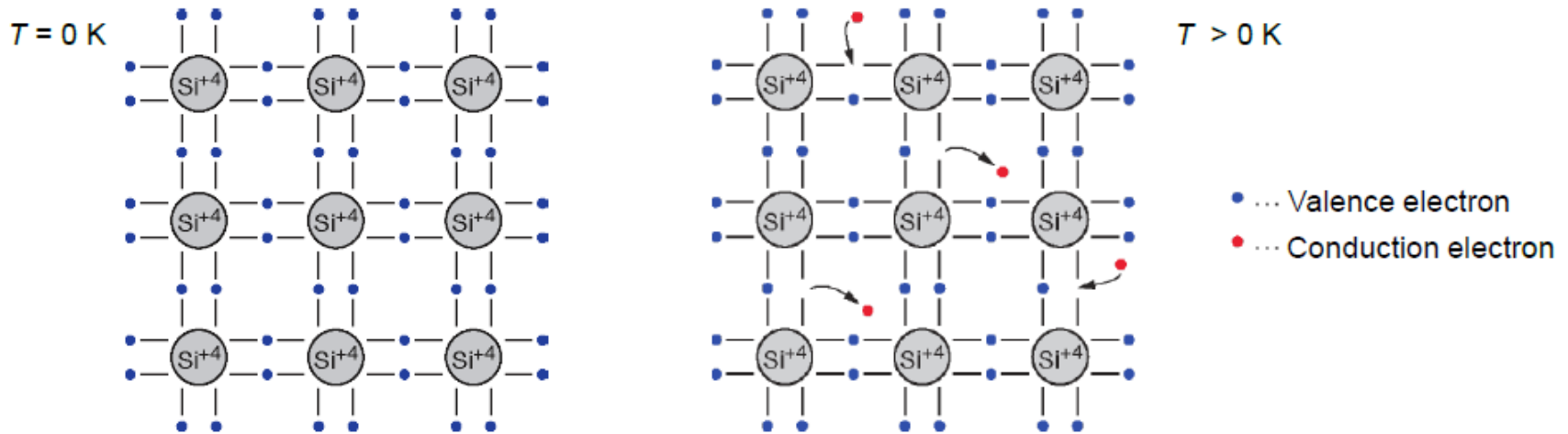

Each atom has 4 closest neighbors, the 4 electrons in the outer shell are shared and form covalent bonds.

- At low temperature all electrons are bound
- At higher temperature thermal vibrations break some of the bonds  $\rightarrow$  free  $e^-$  cause conductivity (electron conduction)
- The remaining open bonds attract other  $e^-$   $\rightarrow$  the "holes" change position (hole conduction)

# Energy bands: isolator – semiconductor - metal

In an isolated atom the electrons have only discrete energy levels. In solid state material the atomic levels merge to energy bands. In **metals** the conduction and the valence band **overlap**, whereas in isolators and semiconductors these levels are **separated** by an energy gap (**band gap**). In isolators this gap is large.

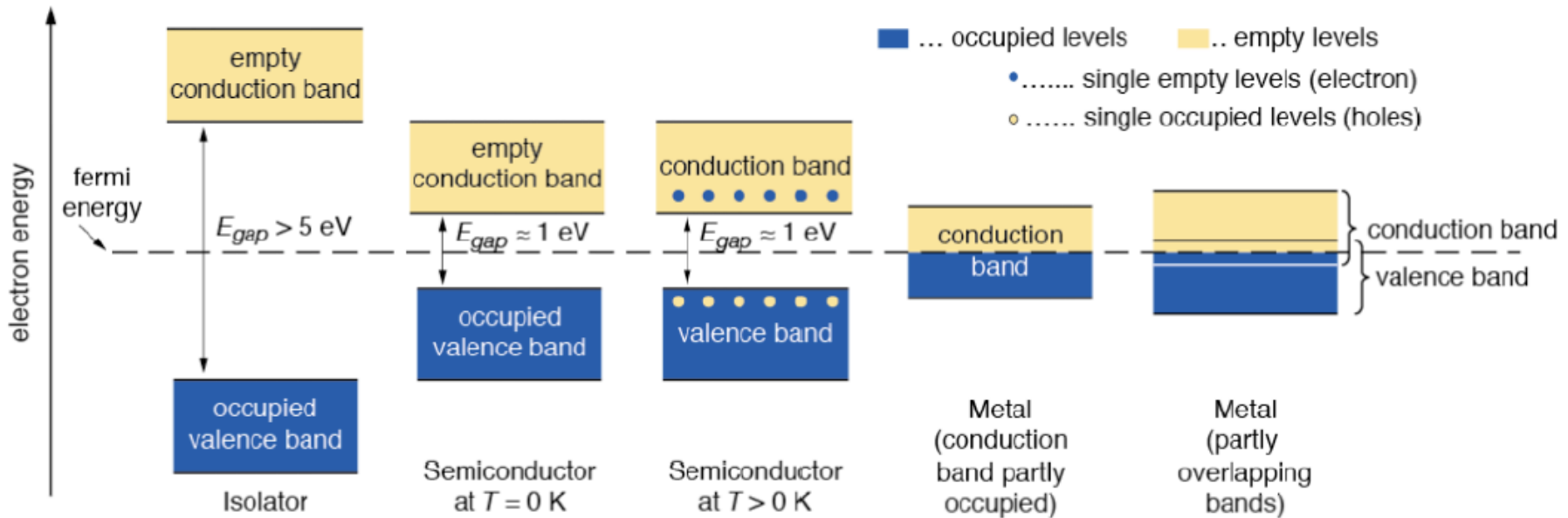

# Fermi distribution, Fermi levels

Fermi distribution  $f(E)$  describes the **probability that an electronic state with energy  $E$  is occupied by an electron**

$$f(E) = \frac{1}{1 + e^{\frac{E-E_F}{kT}}}$$

The **Fermi level  $E_F$**  is the energy at which the **probability of occupation is 50%**. For metals  $E_F$  is in the conduction band, for semiconductors and isolators  $E_F$  is in the band gap

Fermi distribution function for different temperatures

$$T_4 > T_3 > T_2 > T_1 > T_0 = 0 \text{ K}$$

$T_0 = 0 \text{ K}$ : saltus function

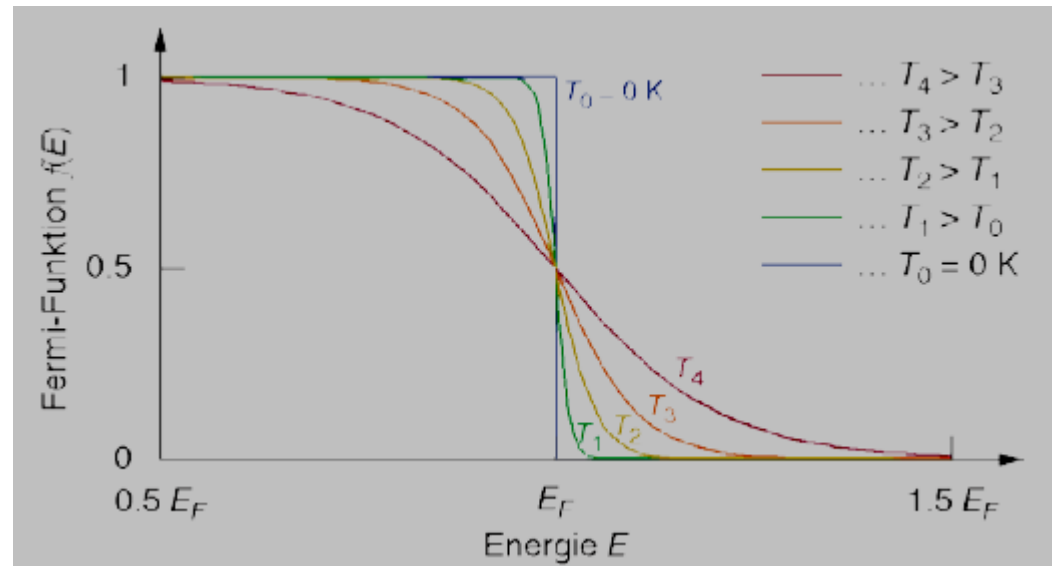



# Intrinsic semi-conductor properties

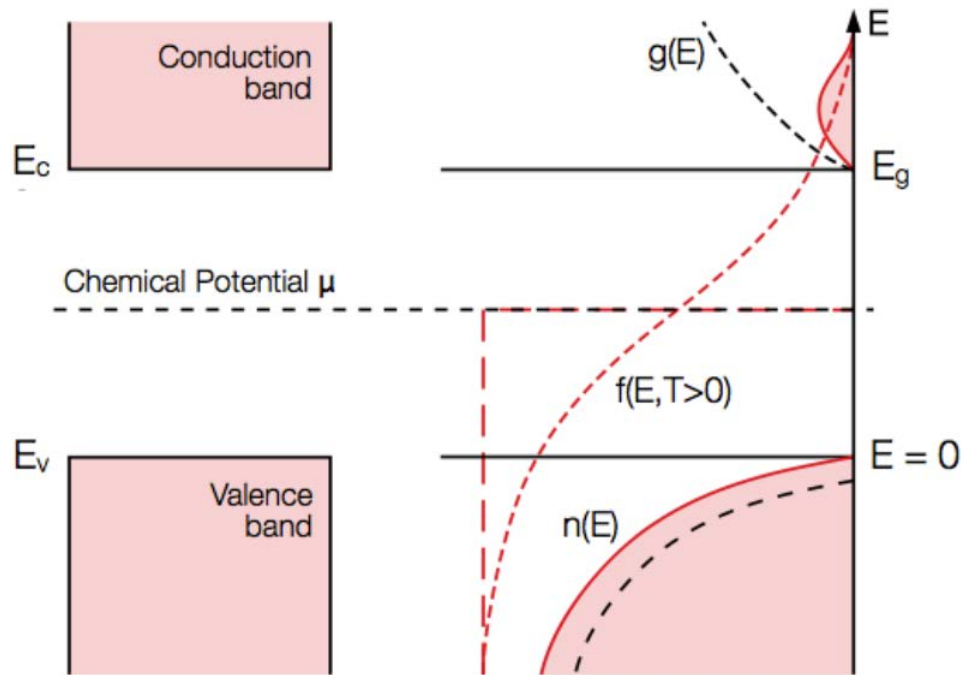

Band structure and electron density

## ❖ Dispersion relation

$$E(\vec{k}) = \frac{\hbar^2 k^2}{2m_e} = \frac{\hbar^2}{2m_e} (k_x^2 + k_y^2 + k_z^2)$$

## ❖ Density of states

$$g(E) = \frac{dN}{dE} = E^{1/2} \cdot \left( \frac{2m_e}{\hbar^2} \right)^{3/2} \frac{V}{2\pi^2}$$

## ❖ Fermi-Dirac distribution

$$f(E, T) = \frac{1}{e^{(E-\mu)/k_B T} + 1}$$

## ❖ Electron density

$$n = \frac{1}{V} \int_0^{E_{max}} g(E) f(E) dE$$

# Drift velocity and mobility

Drift velocity

for electrons:

$$\vec{v}_n = -\mu_n \vec{E}$$

and for holes:

$$\vec{v}_p = -\mu_p \vec{E}$$

Mobility

for electrons:

$$\mu_n = \frac{e \cdot \tau_n}{m_n}$$

and for holes:

$$\mu_p = \frac{e \cdot \tau_p}{m_p}$$

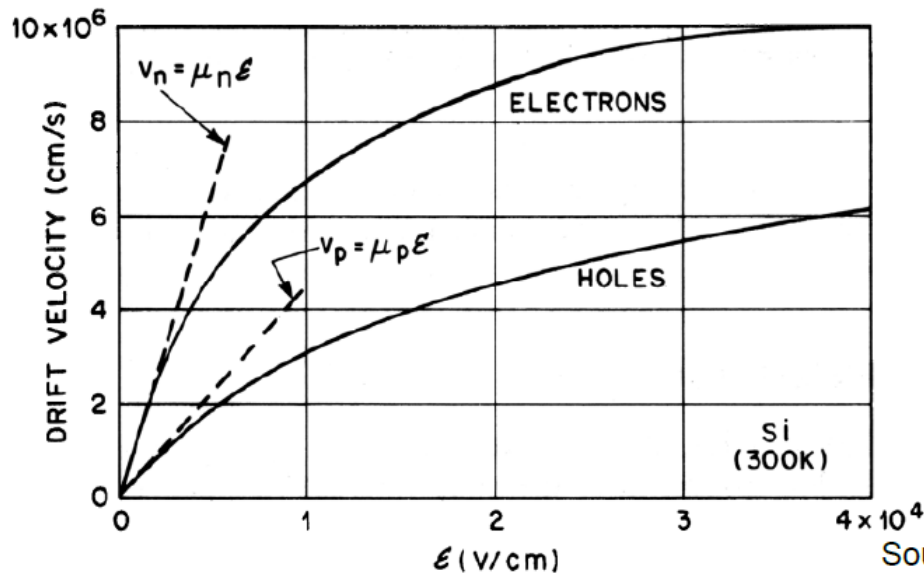

- $e$  ... electron charge
- $E$  ... external electric field
- $m_n, m_p$  ... effective mass of  $e^-$  and holes
- $\tau_n, \tau_p$  ... mean free time between collisions for  $e^-$  and holes (carrier lifetime)

Source: S.M. Sze, *Semiconductor Devices*, J. Wiley & Sons, 1985

# Resistivity

Specific resistivity is a measure of silicon purity

$$\rho = \frac{1}{e(\mu_n n_e + \mu_p n_h)}$$

$n_e, n_h$  ... Charge carrier density for electrons and holes

$\mu_n, \mu_p$  ... Mobility for electrons and holes

$e$  ... elementary charge

Carrier mobilities:  $\mu_p(\text{Si}, 300\text{K}) \approx 450 \text{ cm}^2/\text{Vs}$   
 $\mu_n(\text{Si}, 300\text{K}) \approx 1450 \text{ cm}^2/\text{Vs}$

The charge carrier concentration in pure silicon (i.e. intrinsic Si) for  $T = 300 \text{ K}$  is:

$$n_e = n_h \approx 1.45 \cdot 10^{10} \text{ cm}^{-3}$$

This yields an intrinsic resistivity of:

$$\rho \approx 230 \text{ k}\Omega\text{cm}$$

# Comparison of different semiconductor materials

Material	Si	Ge	GaAs	GaP	CdTe	Diamond*
Atomic number Z	14	32	31+33	31+15	48+52	6
Mass Number A (amu)	28.086	72.61	69.72+74.92	69.72+30.97	112.4+127.6	12.011
Lattice constant a (Å)	5.431	5.646	5.653	5.451	6.482	3.567
Density $\rho$ (g/cm <sup>3</sup> )	2.328	5.326	5.32	4.13	5.86	3.52
$E_g$ (eV) bei 300 K	1.11	0.66	1.42	2.26	1.44	5.47–5.6
$E_g$ (eV) bei 0 K	1.17	0.74	1.52	2.34	1.56	≈ 6
rel. permittivity $\epsilon_r = \epsilon/\epsilon_0$	11.9	16.0	12.8	11.1	10.9	5.7
Melting point (° C)	1415	938	1237	1477	1040	3527
eff. e <sup>-</sup> -mass ( $m_n/m_e$ )	0.98, 0.19	1.64, 0.08	0.067	0.82	0.11	0.2
eff. hole mass <sup>+</sup> ( $m_h/m_e$ )	0.16	0.044	0.082	0.14	0.35	0.25

\*usually considered an isolator

Source: <http://www.ioffe.rssi.ru/SVA/NSM/Semicond/>; S.M.Sze, *Physics of Semicon. Devices*, J. Wiley & Sons, 1981,  
J. Singh, *Electronic & Optoelectronic Properties of Semiconductor Structures*, Cambridge University Press, 2003

# Comparison of different semiconductor materials

Material	Si	Ge	GaAs	GaP	CdTe	Diamond*
eff. density of states in conduction band $n_{CB}$ (cm <sup>-3</sup> )	$3 \cdot 10^{19}$	$1 \cdot 10^{19}$	$4.7 \cdot 10^{17}$	$2 \cdot 10^{19}$		$\approx 10^{20}$
eff. Density of states in valence band $n_{VB}$ (cm <sup>-3</sup> )	$1 \cdot 10^{19}$	$6 \cdot 10^{18}$	$7 \cdot 10^{18}$	$2 \cdot 10^{19}$		$\approx 10^{19}$
Electron mobility $\mu_e$ bei 300 K (cm <sup>2</sup> /Vs)	~1450	3900	8500	< 300	1050	1800
Hole mobility $\mu_h$ bei 300 K (cm <sup>2</sup> /Vs)	~450	1900	400	< 150	100	1200
instrins. charge carrier density at 300 K (cm <sup>-3</sup> )	$1.45 \cdot 10^{10}$	$2.4 \cdot 10^{13}$	$2 \cdot 10^6$	2		$\approx 10^{-27}$
instrins. resistivity at 300 K ( $\Omega$ cm)	$2.3 \cdot 10^5$	47	$\approx 10^8$		$\approx 10^9$	$\geq 10^{42}$
Breakdown field (V/cm)	$3 \cdot 10^5$	$\approx 10^5$	$4 \cdot 10^5$	$\approx 10^6$		$3 \cdot 10^7$
Mean $E$ to create an e-h <sup>+</sup> pair (eV), 300 K	3.62	2.9	4.2	$\approx 7$	4.43	13.25

\*usually considered an isolator

Source: <http://www.ioffe.rssi.ru/SVA/NSM/Semicond/>; S.M.Sze, *Physics of Semicon. Devices*, J. Wiley & Sons, 1981, J. Singh, *Electronic & Optoelectronic Properties of Semiconductor Structures*, Cambridge University Press, 2003

# Constructing a detector

One of the most important parameter of a detector is the **signal-to-noise-ratio** (SNR). A good detector should have a large SNR. However this leads to **two contradictory requirements**:

- **Large signal**
  - low ionization energy → small band gap
- **Low noise**
  - very few intrinsic charge carriers → large band gap

An optimal material should have  $E_g \approx 6 \text{ eV}$

In this case the conduction band is almost empty at room temperature and the band gap is small enough to create a large number of  $e^-h^+$  pairs through ionization.

Such a material exist, it is **Diamond**. However even even artificial diamonds (e.g. CVD diamonds) are too expensive for large area detectors.

# Constructing a detector

- Thickness: 0.3 mm
- Area: 1 cm<sup>2</sup>
- Resistivity: 10 kΩcm
- Mobility (electrons): ~1400 cm<sup>2</sup>/Vs
- Collection time: ~10 ns
- Charge released: ~25000 e~4fC

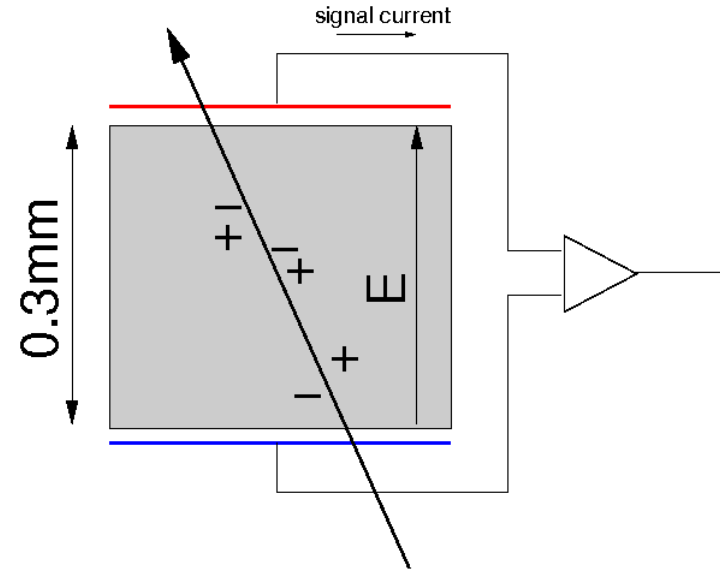

- Need an average field of

$$E = v/\mu = 0.03 \text{ cm}/10 \text{ ns}/1400 \text{ cm}^2/\text{Vs} \sim 21000 \text{ V/cm or } U = 60 \text{ V}$$

# Constructing a detector

Let's make a simple calculation for silicon:

- mean ionization energy  $I_0 = 3.62 \text{ eV}$ .
- mean energy loss per flight path of a mip  $dE/dx = 3.87 \text{ MeV/cm}$

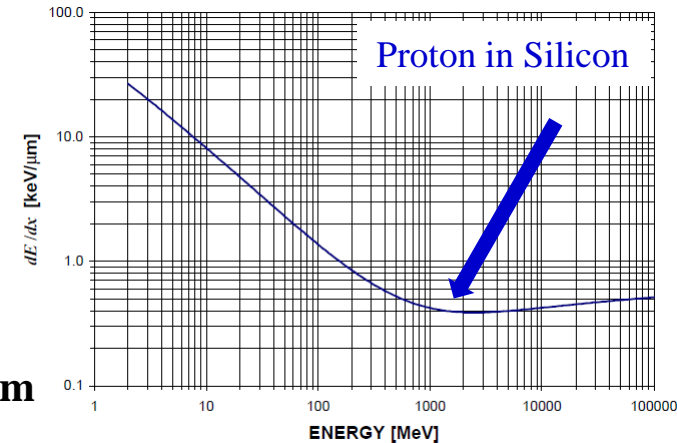

Assuming a detector with a thickness of  $d = 300 \mu\text{m}$  and an area of  $A = 1 \text{ cm}^2$

- **Signal of a mip in such a detector:**

$$\frac{dE/dx \cdot d}{I_0} = \frac{3.87 \cdot 10^6 \text{ eV/cm} \cdot 0.03 \text{ cm}}{3.62 \text{ eV}} \approx 3.2 \cdot 10^4 e^-h^+ \text{ - pairs}$$

- **Intrinsic charge carrier in the same volume ( $T = 300 \text{ K}$ )**

$$n_i \cdot d \cdot A = 1.45 \cdot 10^{10} \text{ cm}^{-3} \cdot 0.03 \text{ cm} \cdot 1 \text{ cm}^2 \approx 4.35 \cdot 10^8 e^-h^+ \text{ - pairs}$$

**Result: the number of thermal created  $e^-h^+$ -pairs (noise is four orders of magnitude larger than the signal).**

We have to remove the charge carriers

→ depletion zone in inverse biased **pn junctions**



A pn junction consists of n and p doped substrates:

- Doping is the **replacement of a small number of atoms** in the lattice by atoms of **neighboring columns** from the periodic table
- These doping atoms create **energy levels within the band gap** and therefore alter the conductivity.

## Definitions:

- An un-doped semiconductor is called an **intrinsic semiconductor**
  - For each conduction electron exists the corresponding hole.
- A doped semiconductor is called an **extrinsic semiconductor**.
  - Extrinsic semiconductors have a abundance of electrons or holes.

# Doping: n- and p-type silicon

## n-type:

- Dopants: Elements with 5 valence electrons, e.g. Phosphorus
- Donators
- Electron abundance

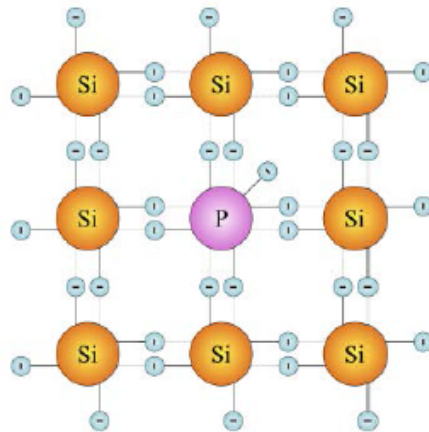

## p-type:

- Dopants: Elements with 3 valence electrons, e.g. Aluminum
- Acceptors
- Electron shortage

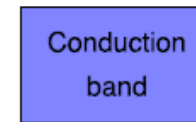
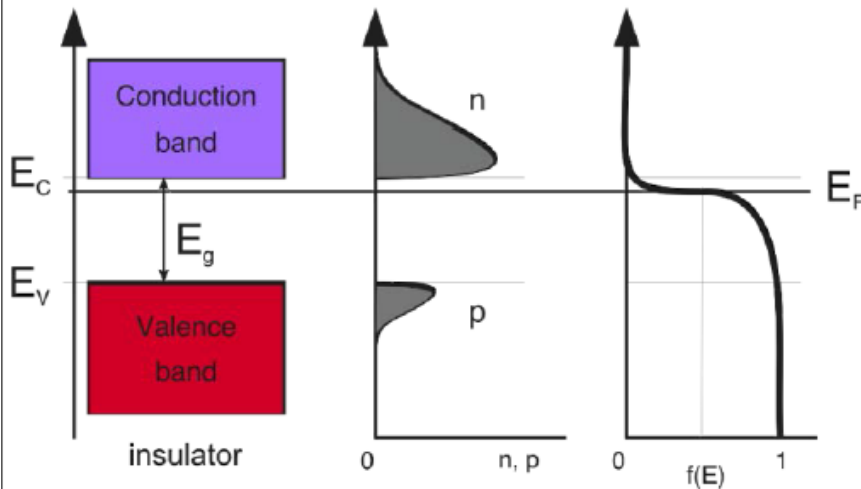
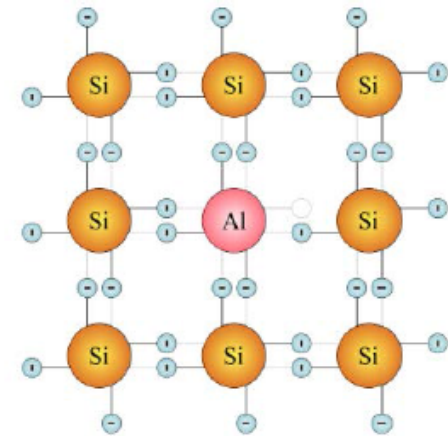

# Bond model: n-doping in silicon

Doping with an element 5 atom (e.g. P, As, Sb). The 5th valence electrons is weakly bound.

The doping atom is called **donor**

The released conduction electron leaves a positively charged ion

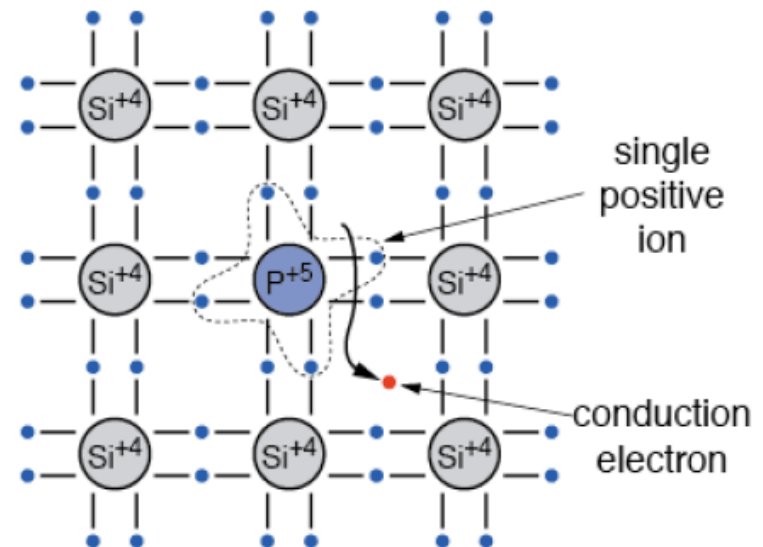
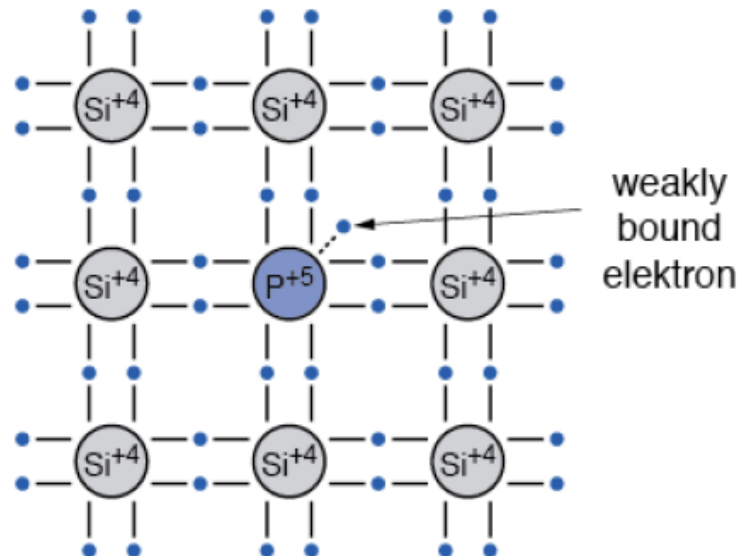

# Band model: n-doping in silicon

The energy level of the donor is just below the edge of the conduction band. At room temperature most electrons are raised to the conduction band. The Fermi level  $E_F$  moves up.

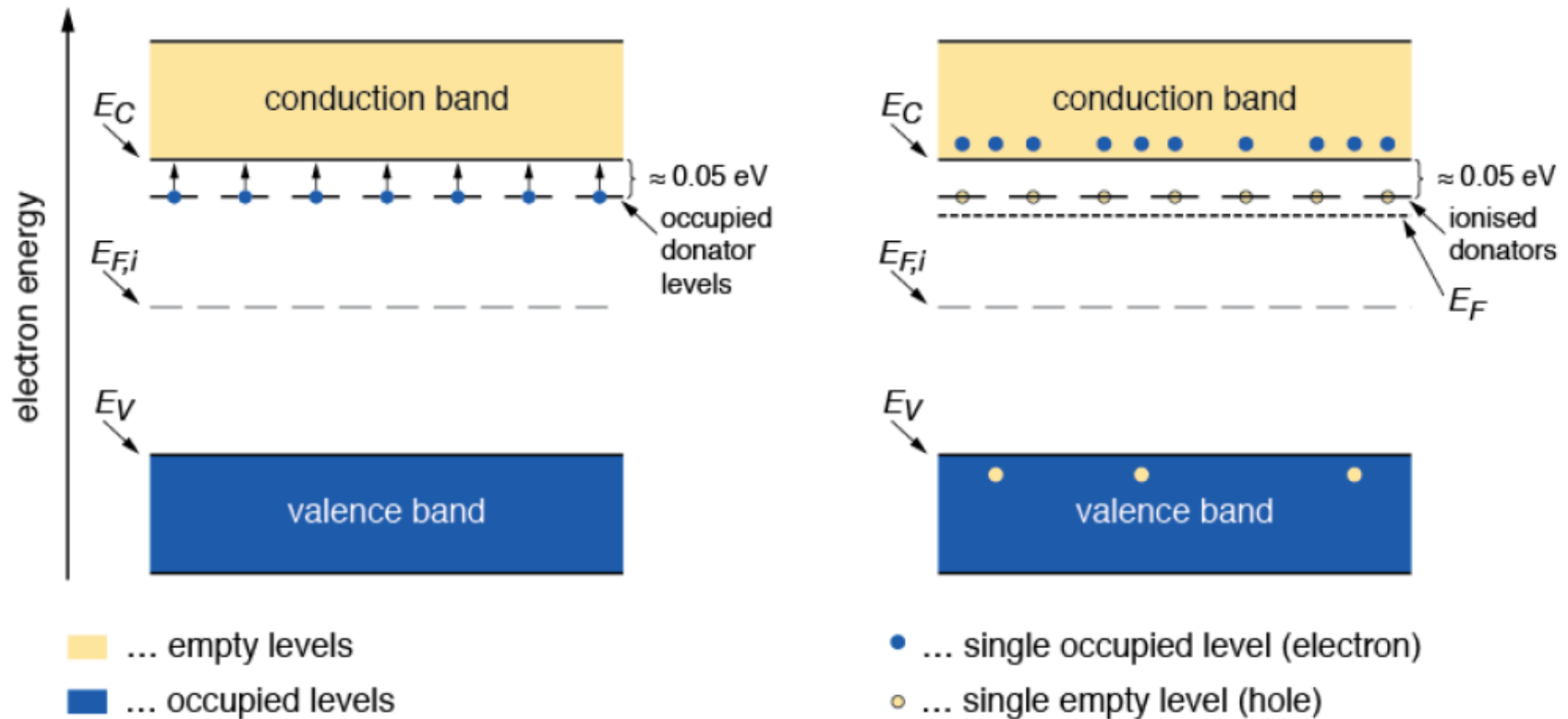

# Bond model: p-doping in silicon

Doping with an element 3 atom (e.g. B, Al, Ga, In). One valence bond remains open. This open bond attracts electrons from the neighbor atoms.

The doping atom is called **acceptor**.

The acceptor atom in the lattice is negatively charged.

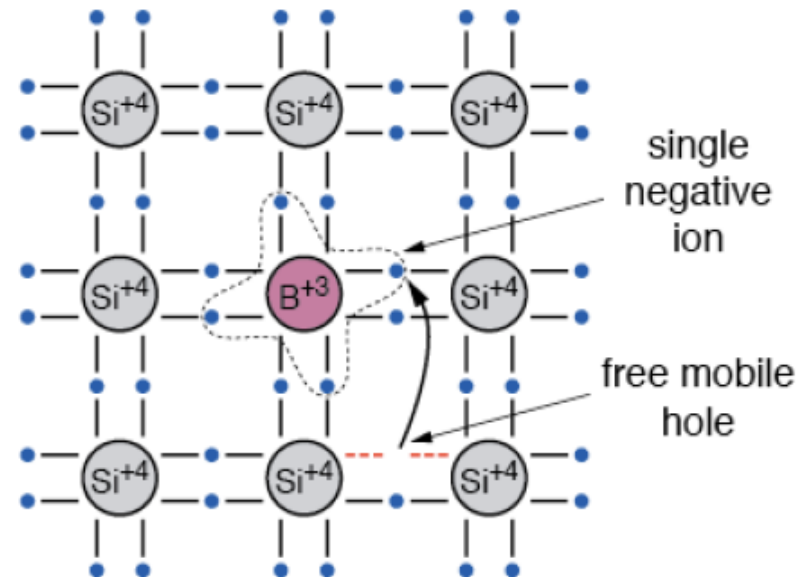
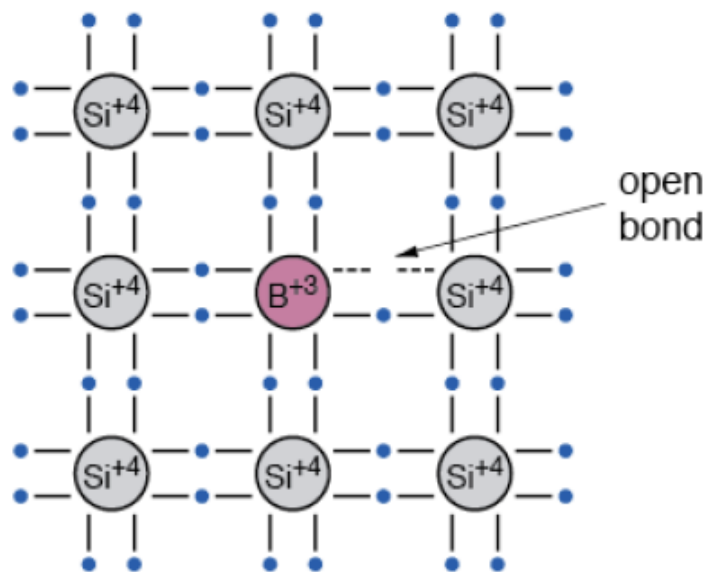

# Band model: p-doping in silicon

The energy level of the acceptor is just above the edge of the valence band. At room temperature most levels are occupied by electrons leaving holes in the valence band.

The Fermi level  $E_F$  moves down.

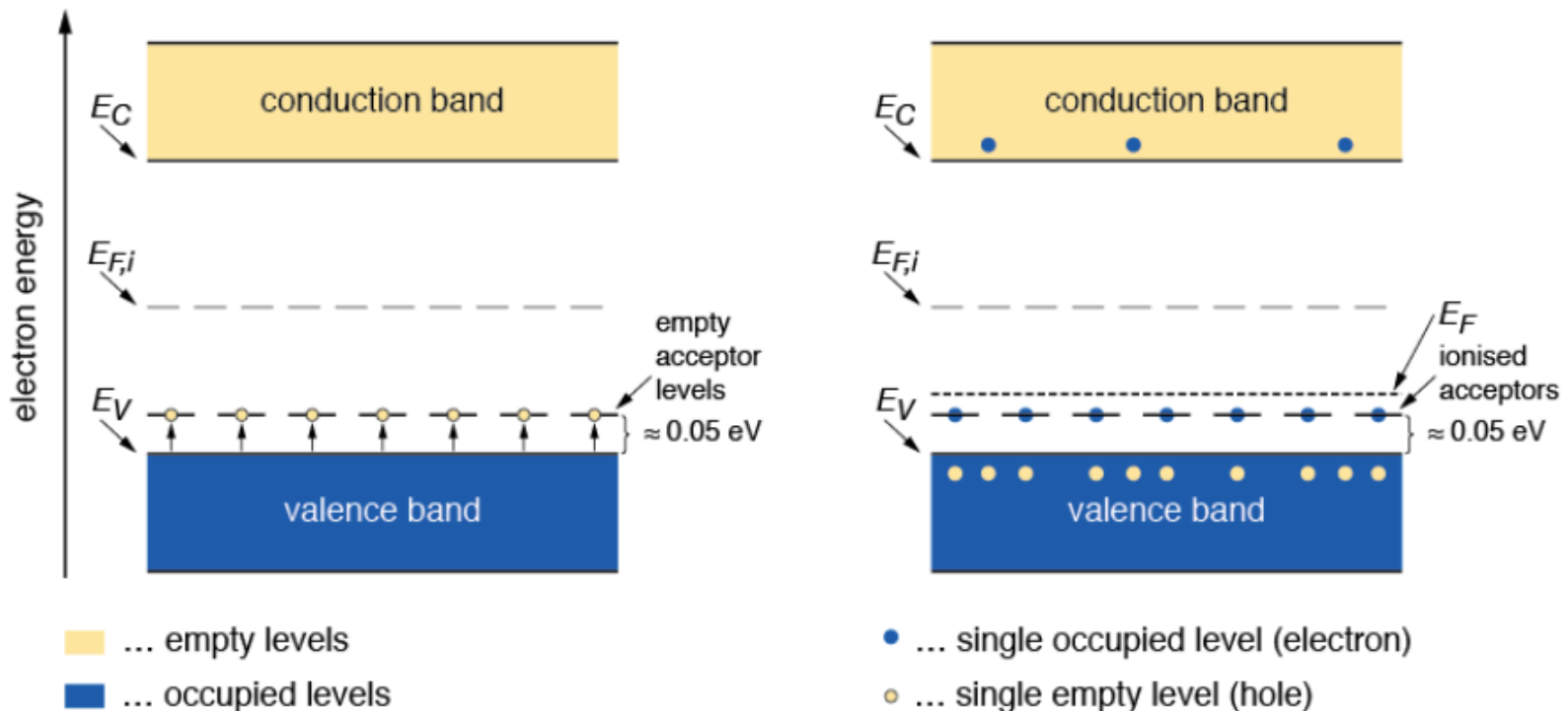



# Creating a pn junction

At the interface of an n-type and p-type semiconductor the difference in the Fermi levels cause diffusion of excessive carries to the other material until thermal equilibrium is reached. At this point the Fermi level is equal. The remaining ions create a **space charge region** and an electric field stopping further diffusion. The stable space charge region is free of charge carries and is called the **depletion zone**.

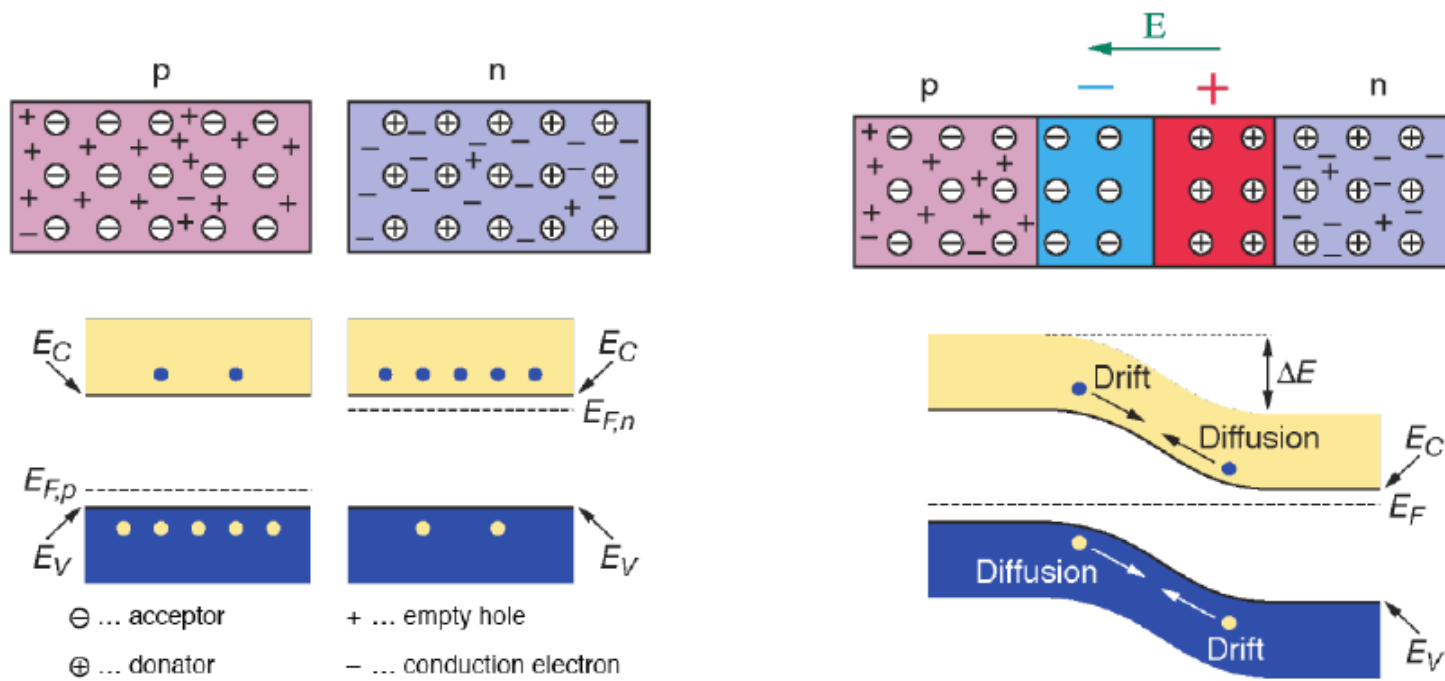



# Electrical characteristics of pn junctions

pn junction scheme

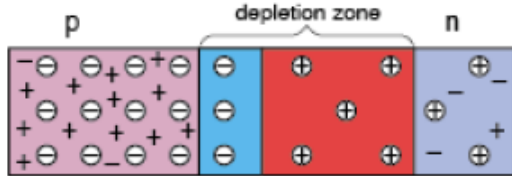

concentration of free charge carriers



acceptor and donator concentration

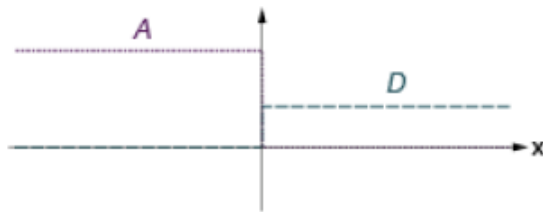

electric field

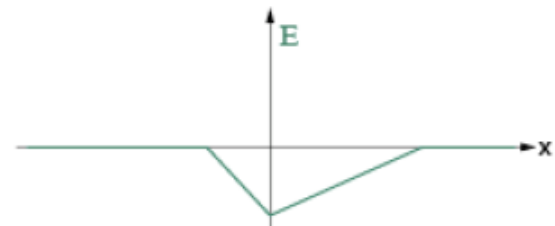

space charge density

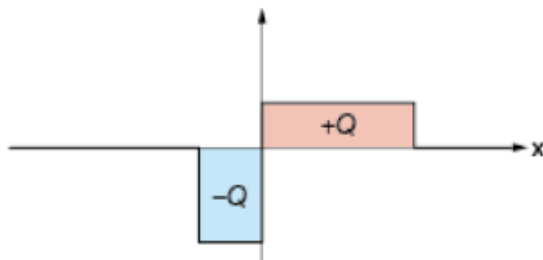

electric potential

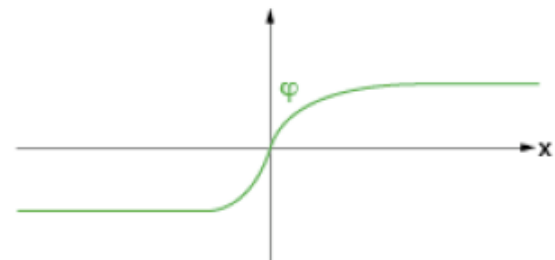

- ⊖ ... acceptor
- ⊕ ... donator
- + ... empty hole
- ... conduction electron

# Operation of a pn-junction with forward bias

Applying an external voltage  $V$  with the anode to p and the cathode to n e- and holes are refilled to the depletion zone. The **depletion zone becomes narrower** (forward biasing)

## Consequences:

- The potential barrier becomes smaller by  $eV$
- Diffusion across the junction becomes easier
- The current across the junction increases significantly.

pn-junction with forward bias

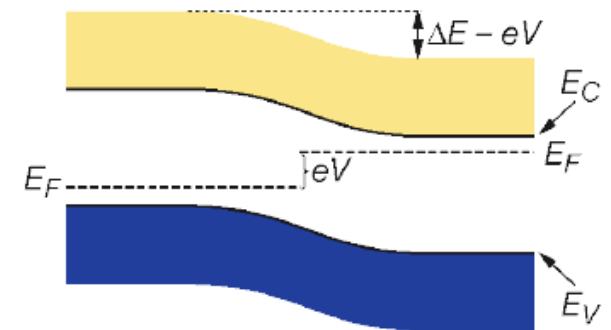
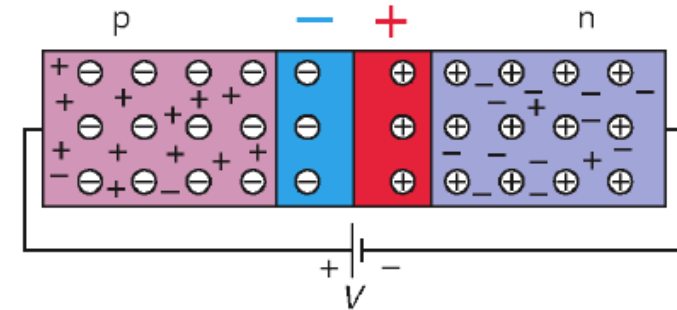

# Operation a pn-junction with reverse bias

Applying an external voltage  $V$  with the cathode to p and the anode to n  $e^-$  and holes are pulled out of the depletion zone. The **depletion zone becomes larger** (reverse biasing).

## Consequences:

- The potential barrier becomes higher by  $eV$
- Diffusion across the junction is suppressed.
- The current across the junction is very small (“leakage current”)

pn-junction with reverse bias

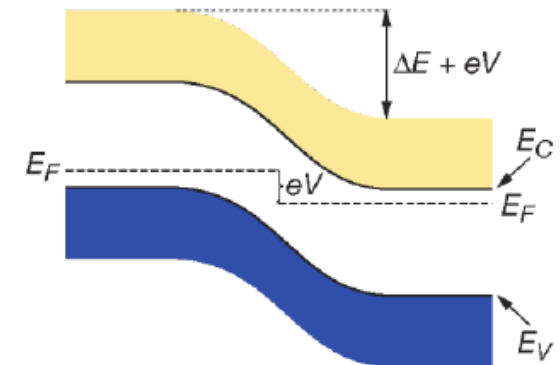
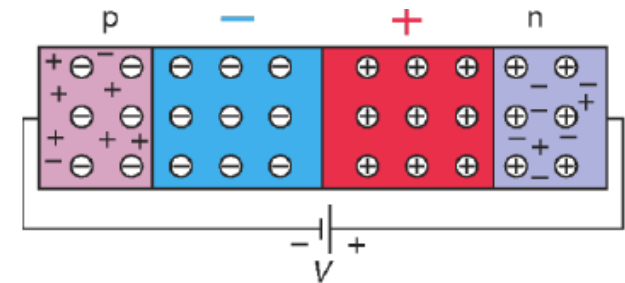

➤ This is the way we operate our semiconductor detector!

# Width of the depletion zone

Effective doping concentration in typical silicon detector with p<sup>+</sup>-n junction

- $N_a = 10^{15} \text{ cm}^{-3}$  in p<sup>+</sup> region
- $N_d = 10^{12} \text{ cm}^{-3}$  in n bulk

**without external voltage:**

$$W_p = 0.02 \text{ } \mu\text{m}$$

$$W_n = 23 \text{ } \mu\text{m}$$

**Applying a reverse bias voltage of 100 V:**

$$W_p = 0.4 \text{ } \mu\text{m}$$

$$W_n = 363 \text{ } \mu\text{m}$$

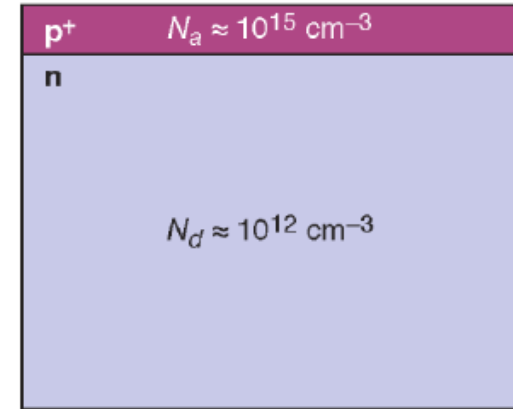

p<sup>+</sup>n junction

Width of depletion zone in n bulk:

$$W \approx \sqrt{2\varepsilon_0\varepsilon_r\mu\rho|V|}$$

with  $\rho = \frac{1}{e\mu N_{eff}}$

- $V$  ... External voltage
- $\rho$  ... specific resistivity
- $\mu$  ... mobility of majority charge carriers
- $N_{eff}$  ... effective doping concentration

# Measurements with Si-detectors

Si-detector



Si-detector with slit cover

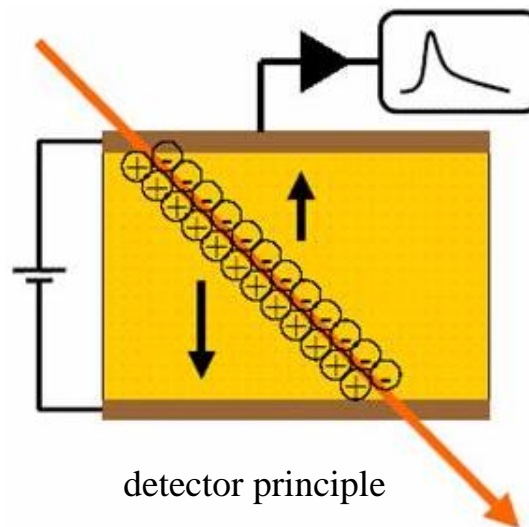

detector principle

Energy loss measurement of  $\alpha$ -particles in air

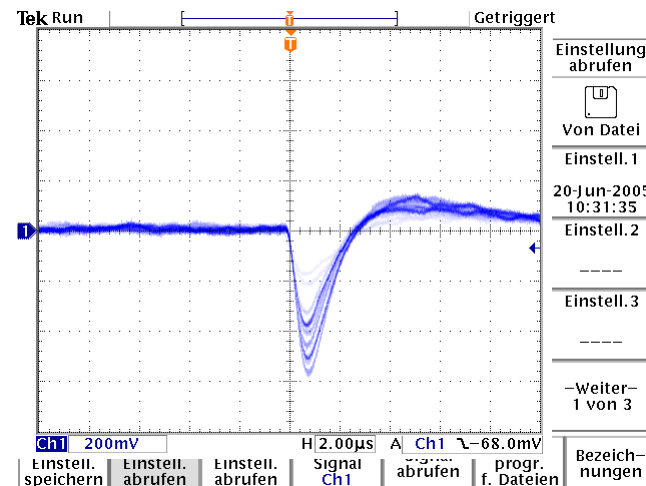
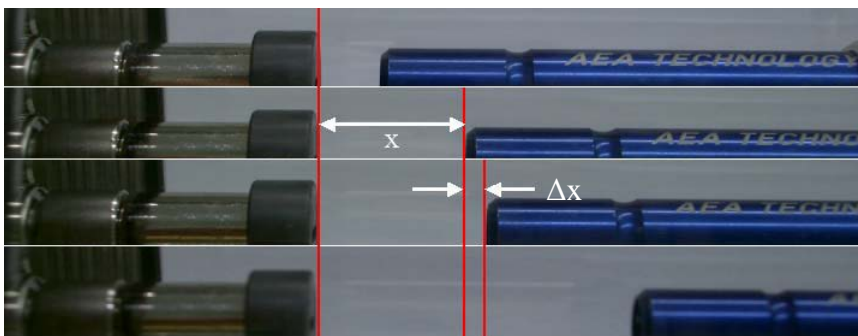

# Surface Barrier Detectors

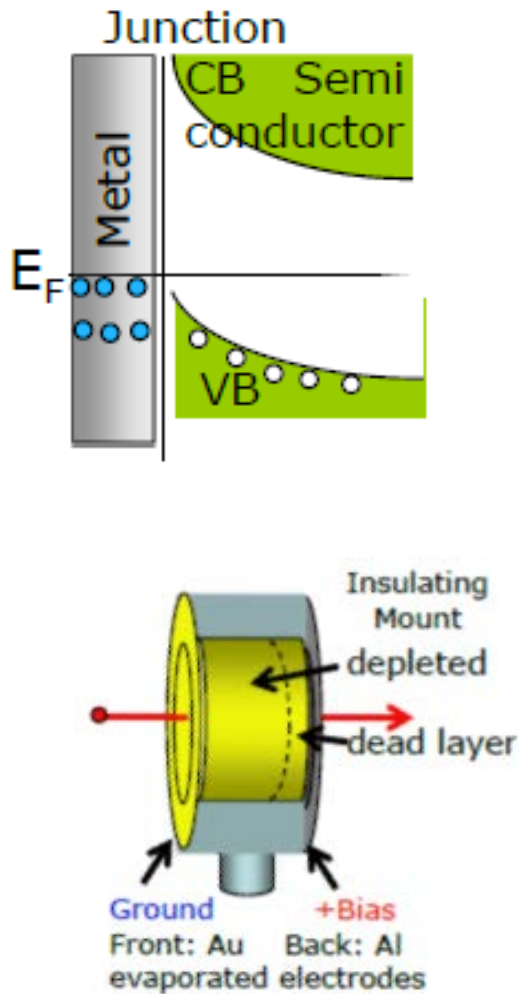

Different Fermi energies adjust to on contact. Thin metal film on Si surface produces space charge, an effective barrier (contact potential) and depleted zone free of carriers. Apply reverse bias to increase depletion depth.

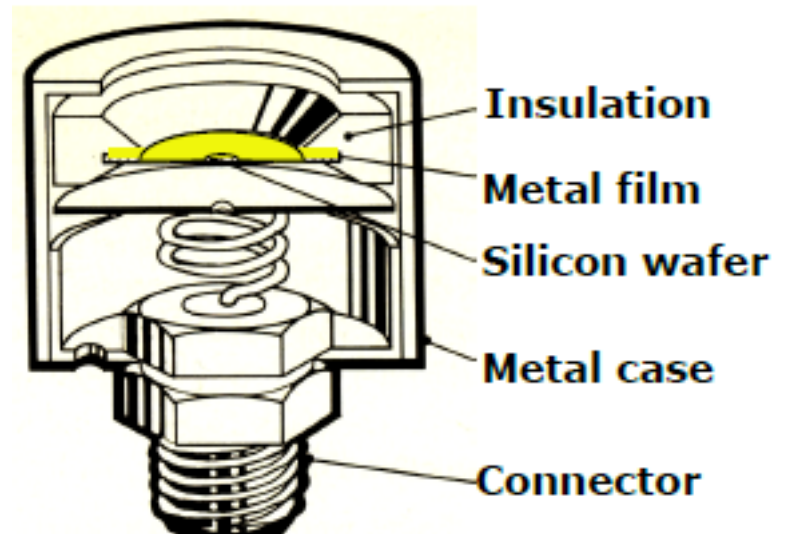

Possible:  
 depletion depth  $\sim 300\mu\text{m}$   
 dead layer  $d_d \leq 1\mu$   
 $V \sim 0.5 \text{ V}/\mu$   
 Over-bias reduces  $d_d$

# Principle of microstrip detector

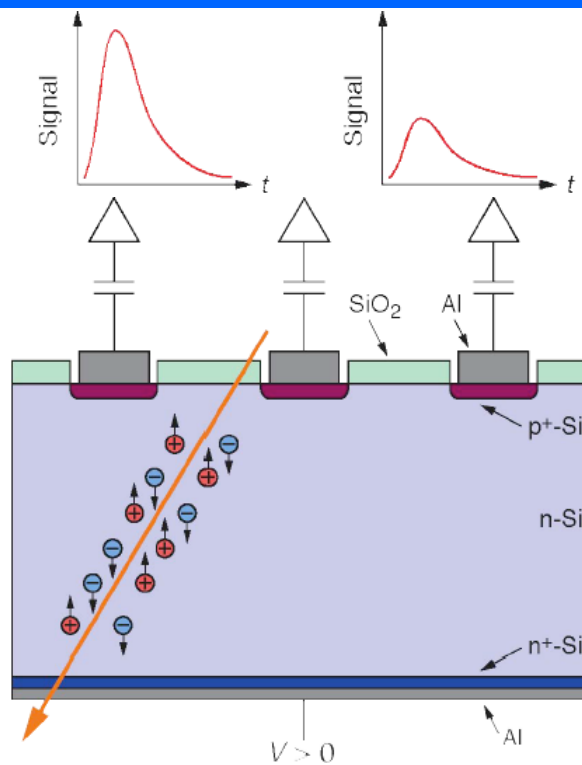
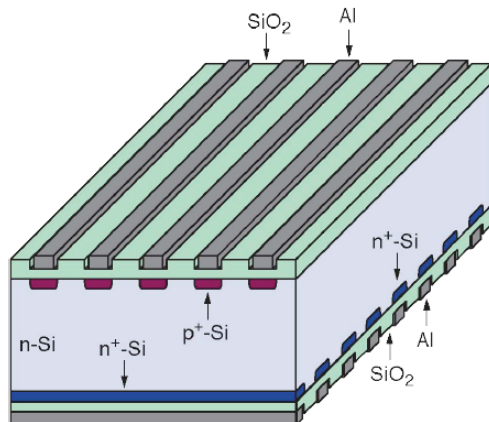
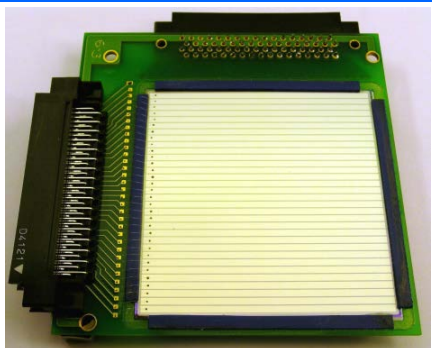

# Germanium detector

## Interaction in a Ge crystal:

- **Photo effect** (low  $\gamma$ -ray energy)
- Compton scattering (medium  $\gamma$ -ray energy)
- Pair production  $e^+e^-$  (high  $\gamma$ -ray energy)

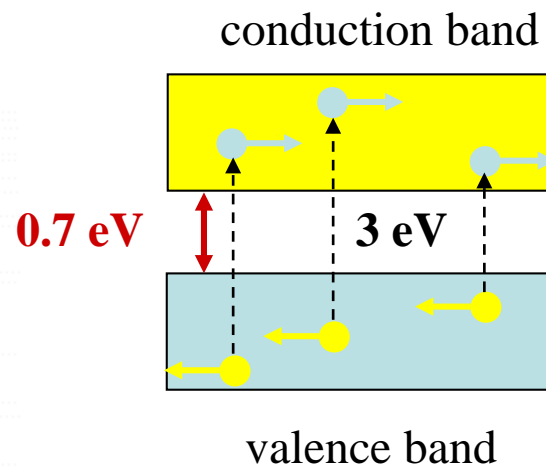
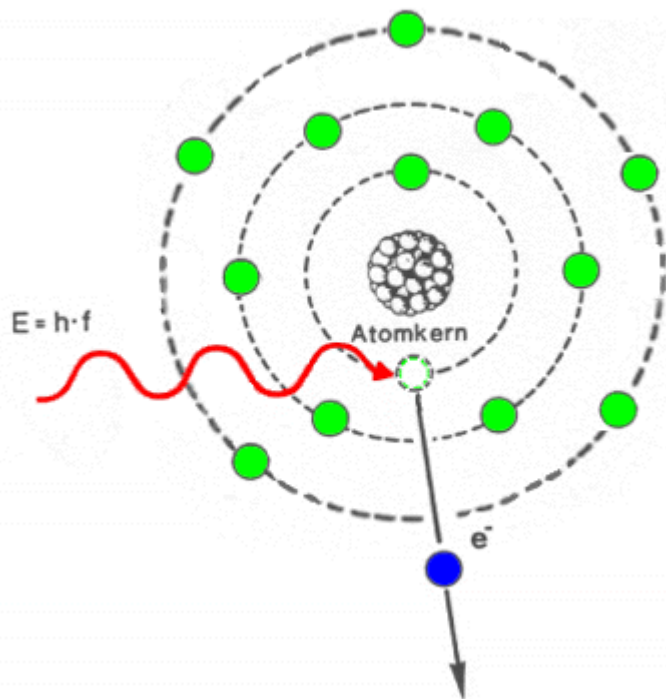

*Number of electron-hole pairs for 1 MeV,  $N = 10^6 / 3 = 3 \times 10^5$*

*energy resolution =  $\sqrt{N} / N = 0.0018 \rightarrow 1.8 \text{ keV} \times \sqrt{E_\gamma}$*



# Germanium detector

## Interaction in a Ge crystal:

- **Photo effect** (low  $\gamma$ -ray energy)
- **Compton scattering** (medium  $\gamma$ -ray energy)
- **Pair production**  $e^+e^-$  (high  $\gamma$ -ray energy)

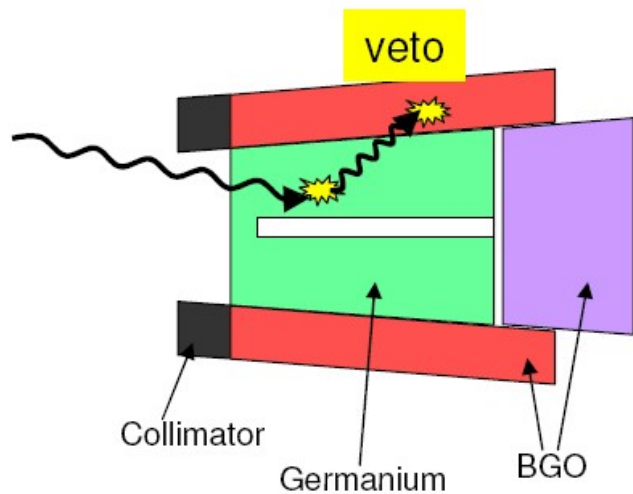

# Compton suppressed Germanium detector

## Interaction in a Ge crystal:

- **Photo effect** (low  $\gamma$ -ray energy)
- **Compton scattering** (medium  $\gamma$ -ray energy)
- Pair production  $e^+e^-$  (high  $\gamma$ -ray energy)

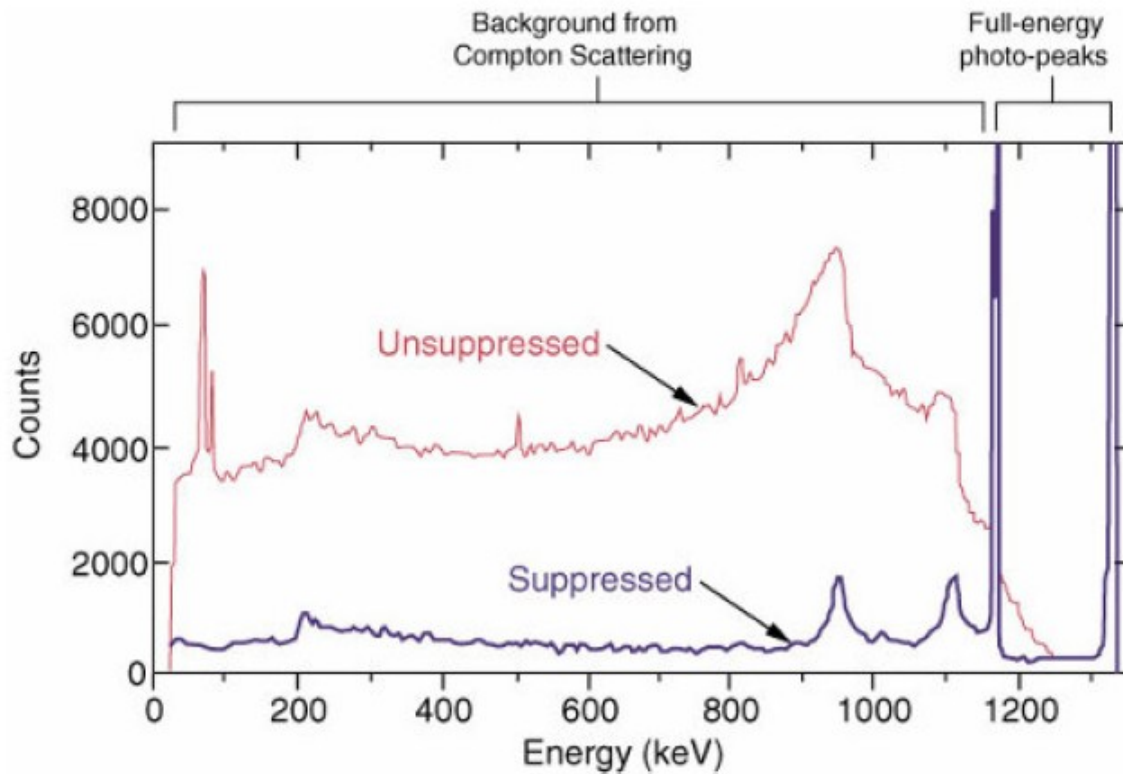

## peak-to-total ratio

- unsuppressed  
P/T~0.15
- Compton suppressed  
P/T~0.6

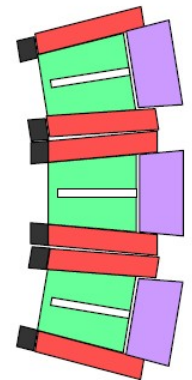

# Gamma-ray spectrum of a radioactive decay

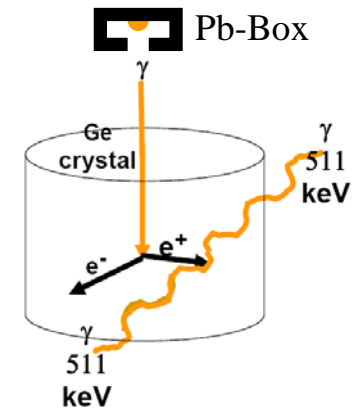
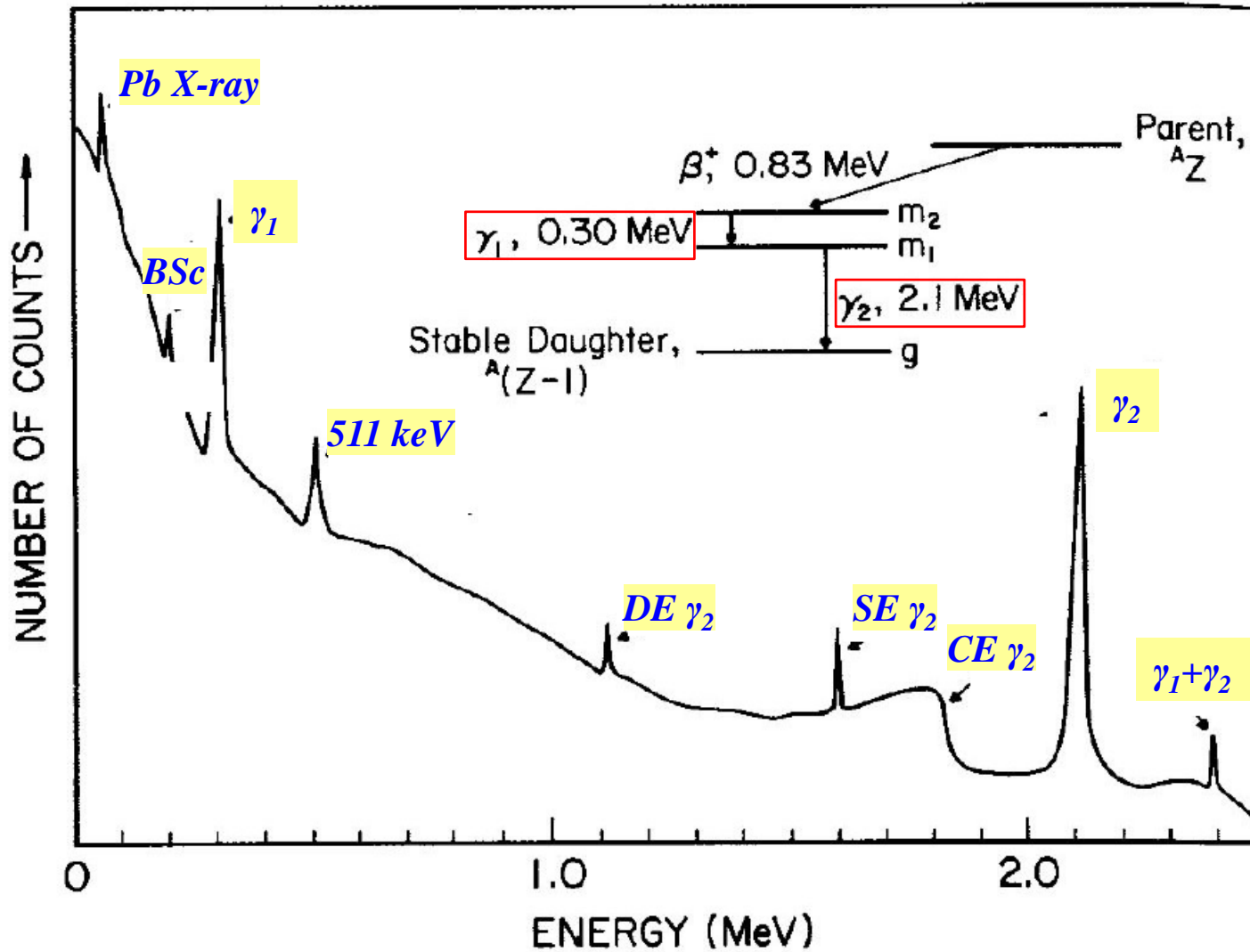

# EUROBALL (*Legnaro / Strasbourg*)

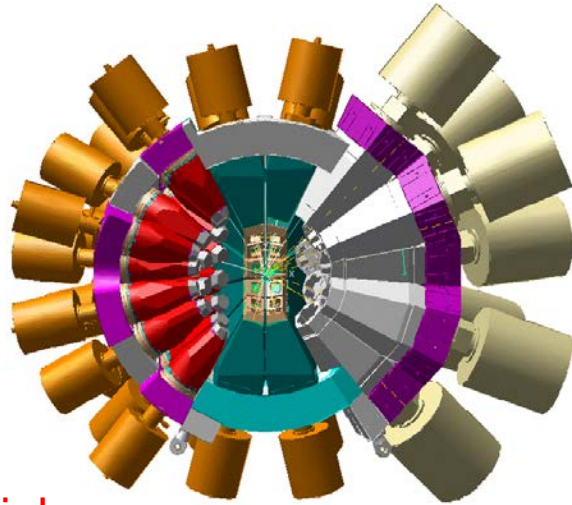

30 coaxial  
detectors

26 four-fold  
Clover detectors

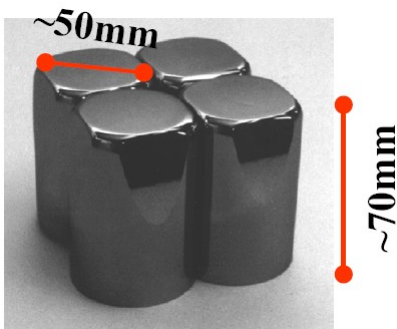

15 seven-fold  
Cluster detectors

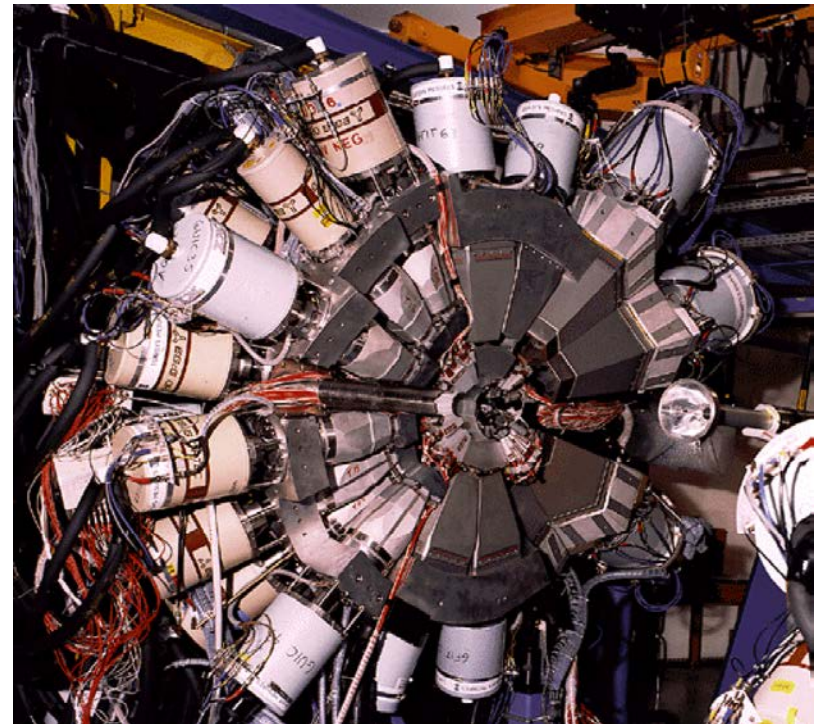
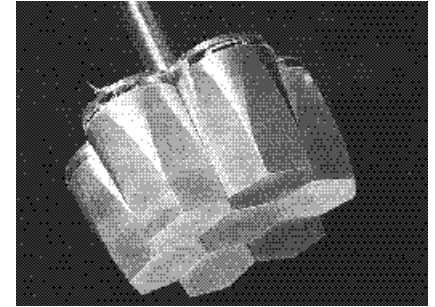

# Making a **H**igh **P**urity **G**ermanium detector

## Coaxial Ge detectors

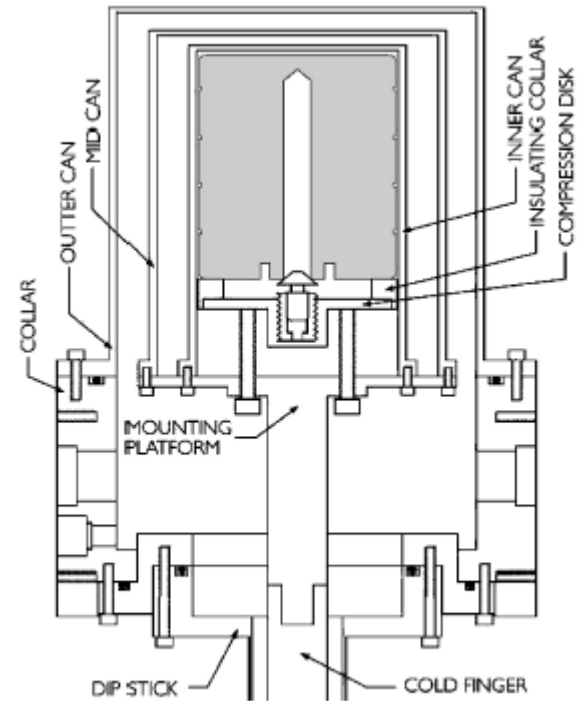
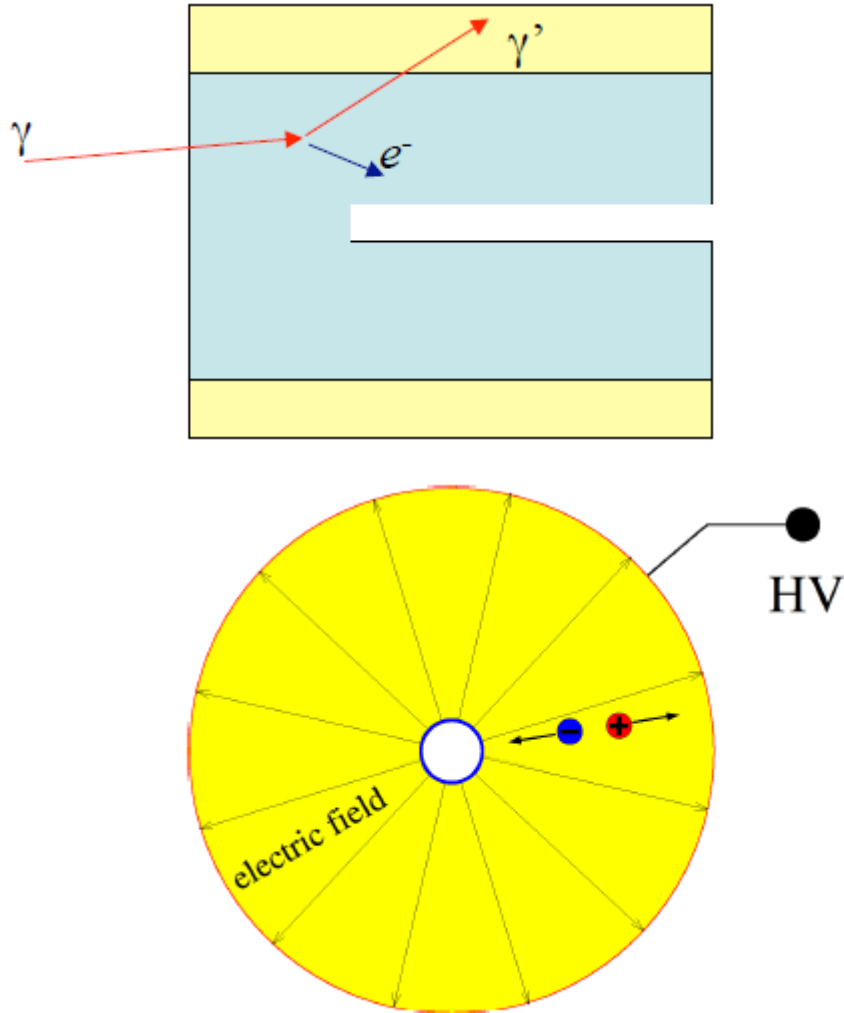

G.S. King et al., NIM A595 (2008) 599-

The hard part: **Don't spoil purity of the Ge crystal**  
(HPGe  $10^{10}$  imp./cm<sup>3</sup>; e.g. 1ng Cu =  $10^{13}$  atoms and  
 $10^9$  Cu atoms per cm<sup>3</sup> already deteriorates FWHM  
[L. Van Goethem et al., NIM A240 (1985) 365])