

# PHL424: Nuclear fission

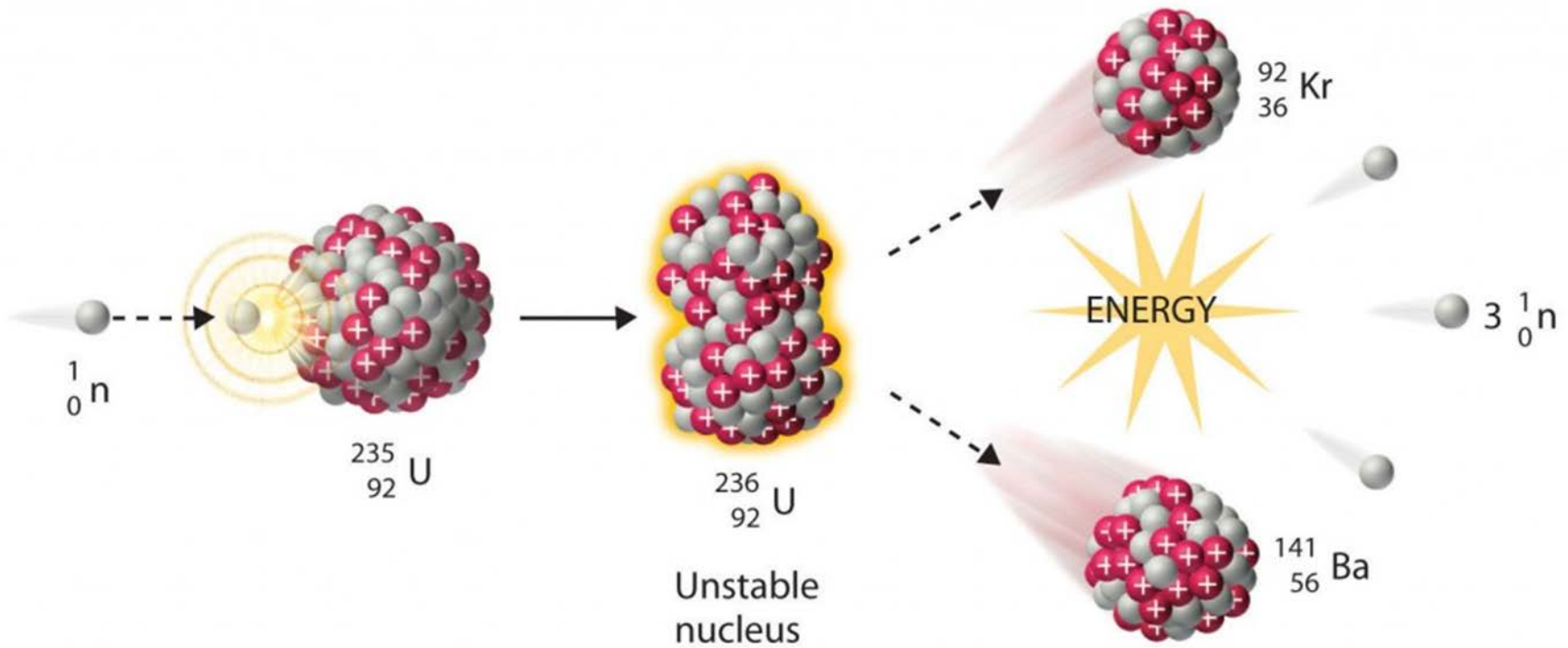

Lise Meitner, Otto Hahn

# Discovery of fission and the chain reaction

- 1932 Discovery of the neutron by James Chadwick  
( ${}^4\text{He} + {}^9\text{Be} \rightarrow {}^{12}\text{C} + {}^1\text{n} + \gamma$ )  
(Nobel prize 1935)

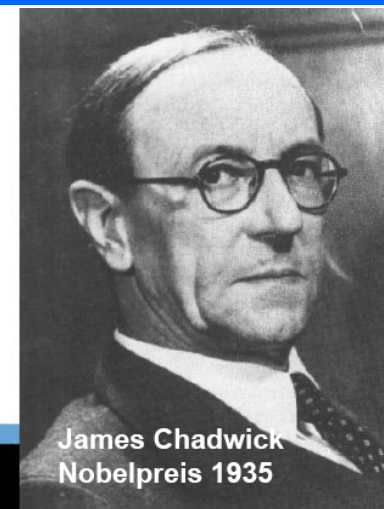
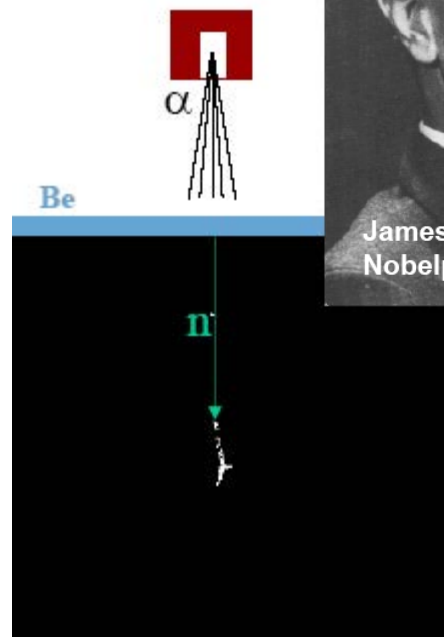

- 1933 Fermi bombarded different nuclei with moderated neutrons and discovered the induced radioactivity  
(Nobel prize 1938 und emigration)



Enrico Fermi (1901-1954)  
Theoretician and experimentalist;  
Fermi statistics, weak interaction,  
first nuclear reactor

# Discovery of fission and the chain reaction

- 1938 Discovery of nuclear fission by Hahn, Meitner, Strassmann using radiochemical methods to verify the fission product Barium (Nobel price 1944 without L.M.)



Otto Hahn (1879-1968)  
Lise Meitner (1878-1968)  
(Emigration 1938)  
Fritz Strassmann (1902-1980)

- 1939 Detection of fission neutrons, with the potential of a chain reaction (Szilard predicted this in 1933)
- 1942 Start of the Manhattan projekt, initiator Szilard (1939 letter from Szilard, Einstein, Wigner to Roosevelt)
- 1942 Fermi builds a nuclear reactor and achieved the first controlled nuclear fission reaction
- 1945 Atomic bomb (fission of U-235 and Pu-239) dropped on Hiroshima und Nagasaki

# Uranium decay

❖ In a **Supernova-explosion**, approximately 6 billion years ago, the isotopes Uranium-238 ( $T_{1/2} = 4.5 \times 10^9$  years), Uranium-235 ( $T_{1/2} = 0.7 \times 10^9$  years) and Plutonium-239 ( $T_{1/2} = 24 \times 10^3$  years) have been produced in equal parts.

Today Pu-239 is completely decayed, while from U-235 and U-238 0.3 % and 40 % are left over, respectively. Uranium fuel elements require a U-235 enrichment of at least 3 %.

❖ Good Uranium mining means a content of 0,3 % Uranium in sedimentary rock and it will be mined for \$50/kg Uranium, the world reserve amounts to about 10 Mio tons of natural Uranium. In addition,  $100 \times 10^6$  tons are estimated in rocks with mining costs of \$300/kg. Certain are  $4,2 \times 10^9$  tons of natural Uranium in sea water which can be extracted for \$500/kg.

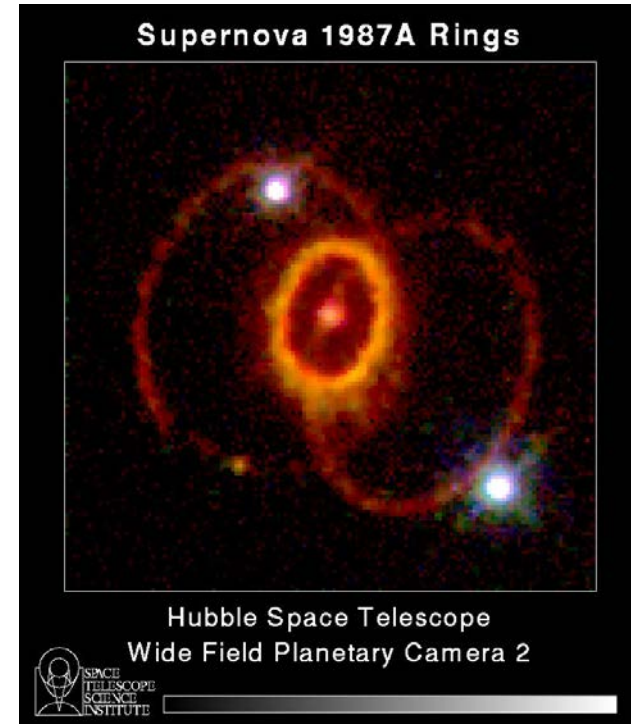

Uranium is a silver white shining, soft heavy metal

## ➤ Alpha-decay:

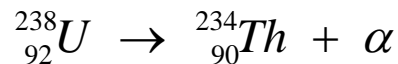

## ➤ Spontaneous fission:

- decay of natural Uranium isotopes

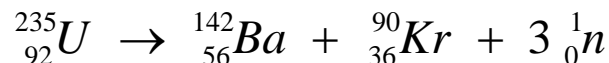
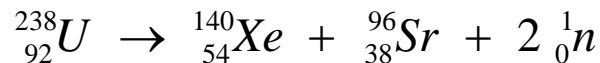

# Energy gain for $^{235}\text{U}$

**Energy balance** of  $^{235}_{92}\text{U}$  - fission

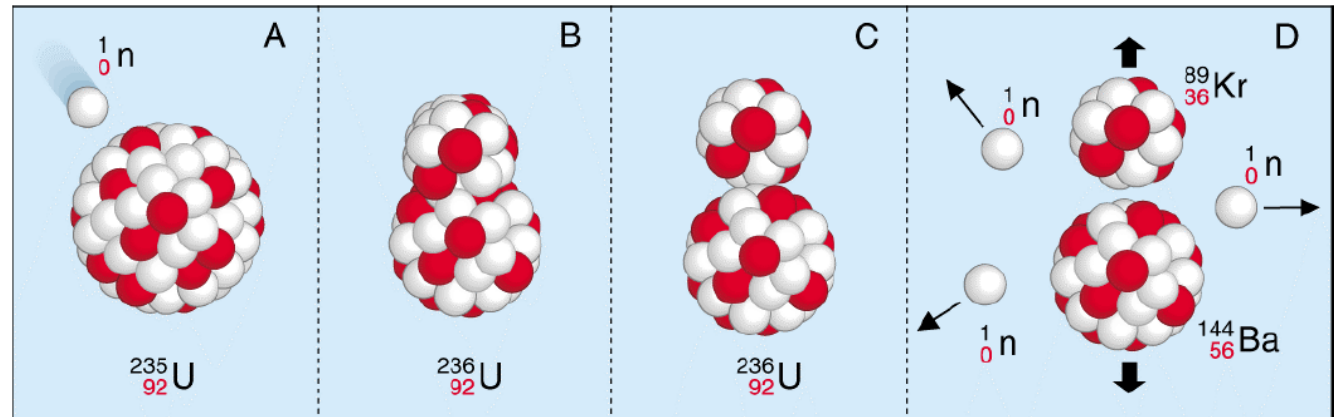

**Mass data:** [nucleardata.nuclear.lu.se/database/masses/](http://nucleardata.nuclear.lu.se/database/masses/)

**Mass** ( $1\text{u}=931.478\text{MeV}/c^2$ ):

$236.045562\text{u} \rightarrow 88.917633\text{u} + 143.922940\text{u} + 3.025995\text{u}$

Energy gain:  $166.73\text{MeV}$

**Binding energy** [ $M(A,Z) - Z \cdot M(^1\text{H}) - N \cdot M(^1\text{n})$ ]:

$-1790.415\text{MeV} \rightarrow -766.908\text{MeV} - 1190.239\text{MeV}$

Energy gain:  $166.73\text{MeV}$



**1g Uranium  $\rightarrow$  fission products 68 Million kJ**

**Mass excess** [ $M(A,Z) - A$ ]:

$42.441\text{MeV} \rightarrow -76.725\text{MeV} - 71.780\text{MeV} + 24.214\text{MeV}$

Energy gain:  $166.73\text{MeV}$



# Spontaneous nuclear fission

**Fission** is caused in heavy nuclei by the increasing **Coulomb force** between the protons.

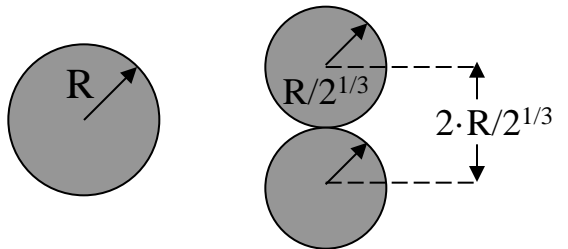

$$V_C = \frac{Z^2 \cdot e^2}{8 \cdot (1/2)^{1/3} \cdot r_0 \cdot A^{1/3}} = 0.189 \cdot \frac{Z^2}{A^{1/3}} \quad [\text{MeV}]$$

$$E_{\text{exp}} = 0.1071 \cdot \frac{Z^2}{A^{1/3}} + 22.2 \quad [\text{MeV}]$$

## Fission fragments are deformed

The surface energy and the Coulomb energy is changed due to the ellipsoidal deformation during the fission process.

By examining both energy terms one realizes that nuclei with  $Z^2/A \geq 51$  undergo fission spontaneously.

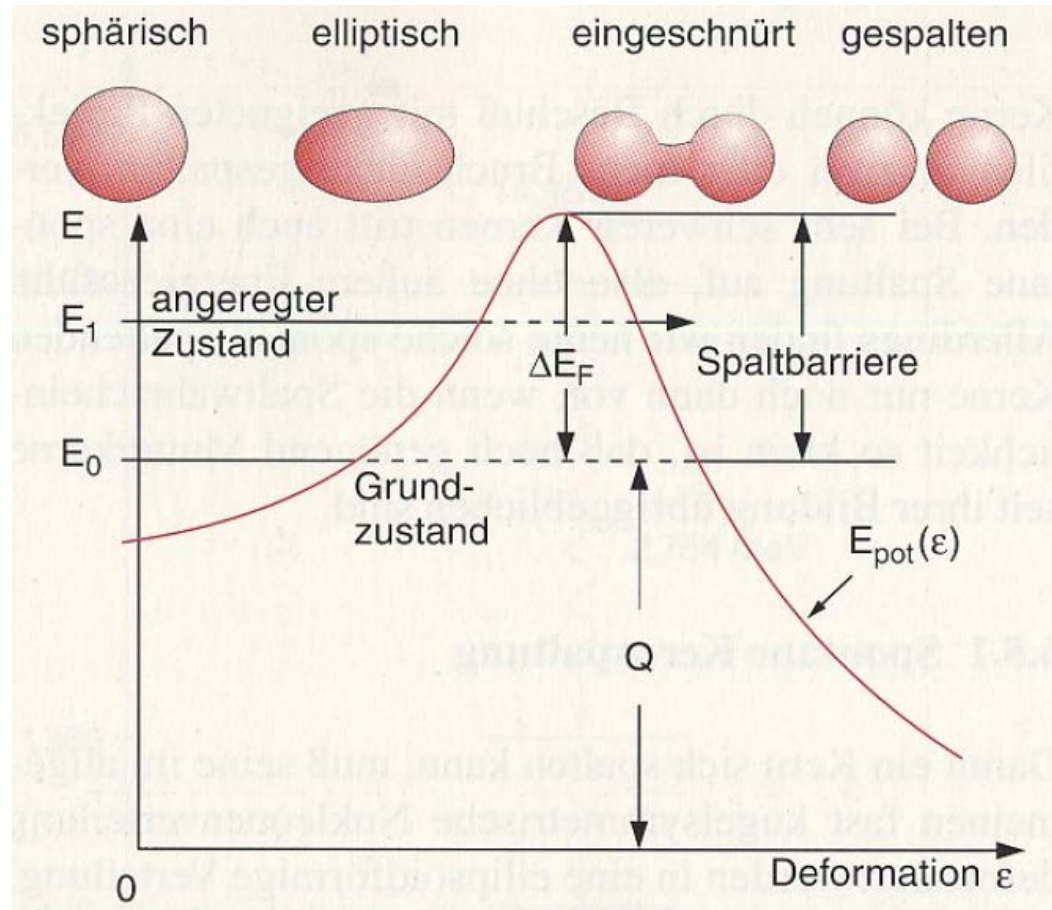

$$X_s = \frac{1}{2} \cdot \frac{E_C}{E_S} = \frac{a_C}{2 \cdot a_S} \cdot \frac{Z^2}{A} > 1$$

# Spontaneous nuclear fission

## Fission barrier:

$$\Delta E_F = E_{Coul} - E_0$$

## liquid drop model:

$$\frac{\Delta E_F}{E_S^0} = \begin{cases} 0.38 \cdot (0.75 - X_s) & 1/3 < X_s < 2/3 \\ 0.83 \cdot (1 - X_s)^3 & 2/3 < X_s < 1 \end{cases}$$

$$E_S^0 = 17.9439 \cdot \left[ 1 - 1.7826 \cdot \left( \frac{N-Z}{A} \right)^2 \right] \cdot A^{2/3} \quad [MeV]$$

$$E_C^0 = 0.7053 \cdot \frac{Z^2}{A^{1/3}} \quad [MeV]$$

$$X_s = \frac{1}{2} \cdot \frac{E_C^0}{E_S^0} \quad \text{this ratio plays an enormous role}$$

Cohen, Plasil, Swiatecki, Ann. of Phys. 82 (1974), 557

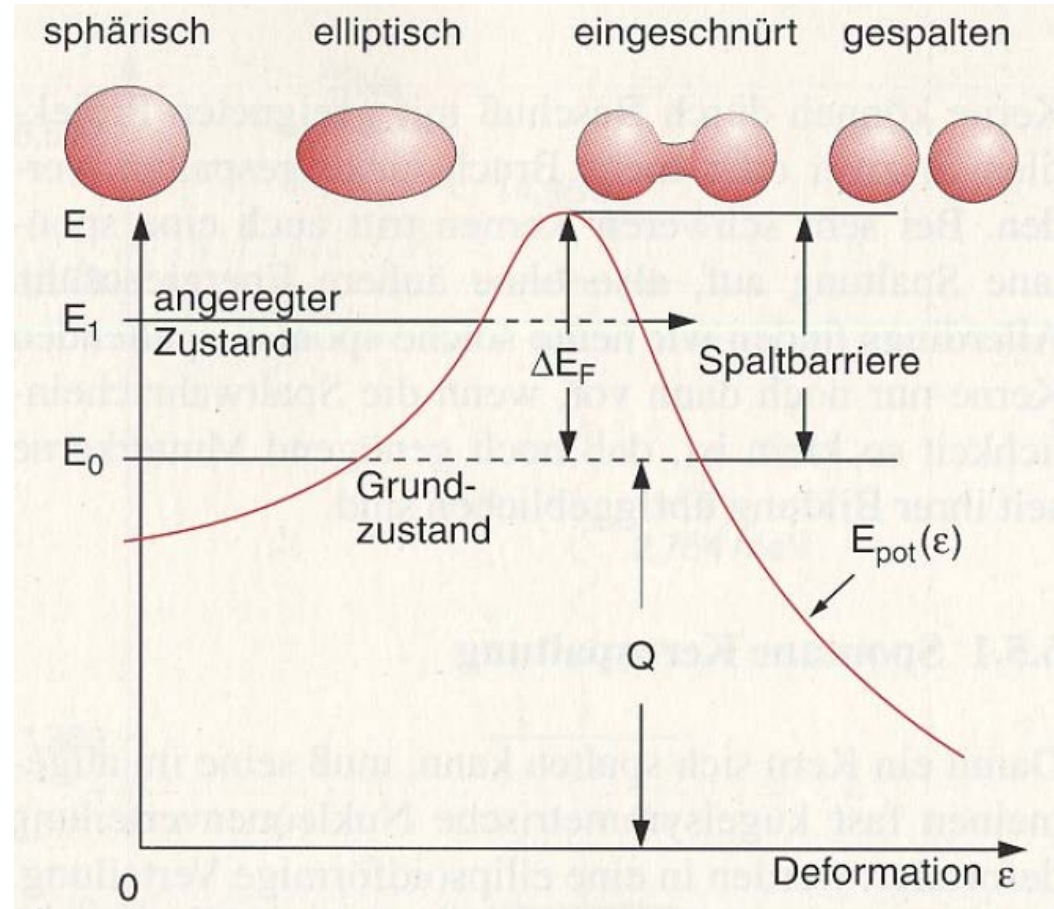

	$Z^2/A$	$E_S^0$ [MeV]	$E_C^0$ [MeV]	$X_s$	$\Delta E_F$ [MeV]
$^{235}\text{U}$	36.02	626.0	967.4	0.773	6.1
$^{238}\text{U}$	35.56	625.9	963.3	0.770	6.4

# Energy barrier for spontaneous fission

For nuclei with  $Z^2/A < 51$  one has to add energy  $\Delta E_F$  in order to observe fission. However, fission is still possible due to the tunneling effect.

The probability for tunneling decrease however very rapidly with decreasing values of  $Z^2/A$ , since the fragments have comparatively large masses.

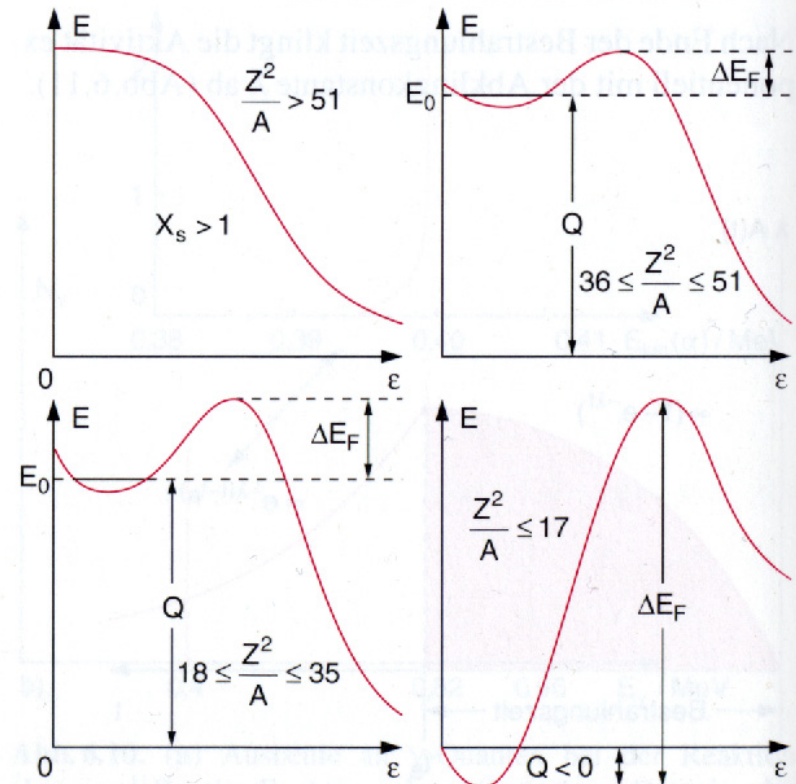

**Abb. 6.13.** Potentialschwelle  $\Delta E_F$  für die Kernspaltung für verschiedene Werte des Verhältnisses  $Z^2/A$



# Double humped fission barrier

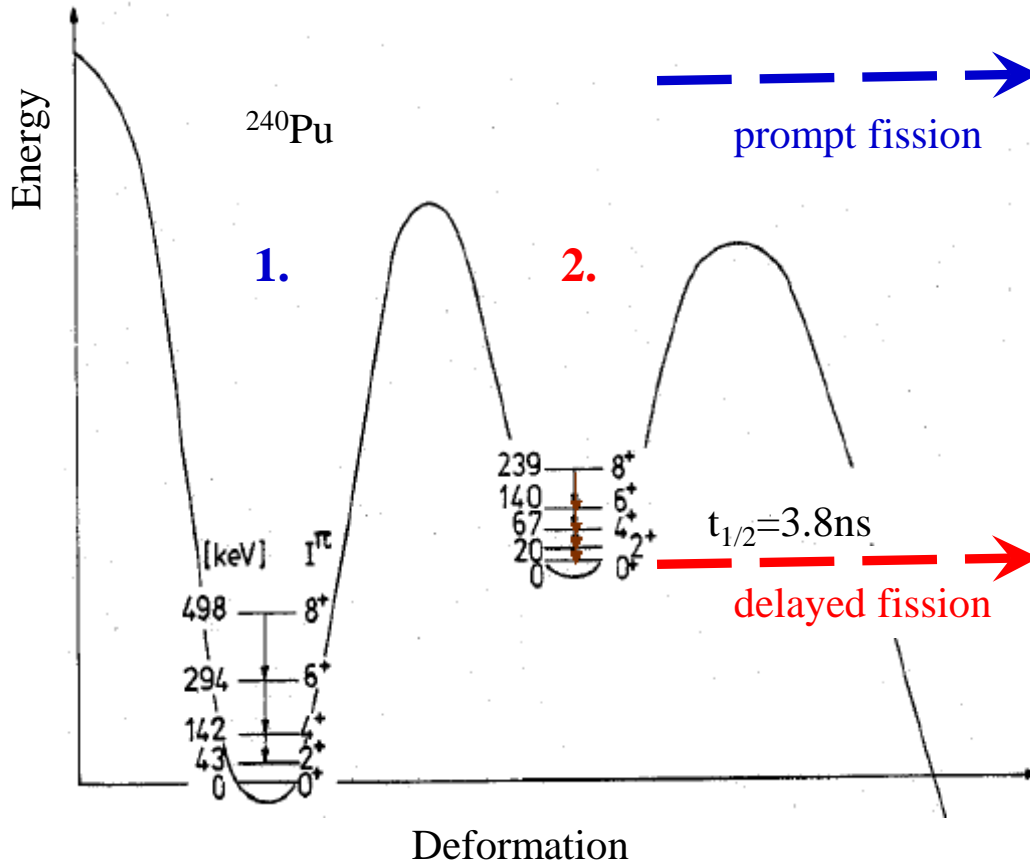

$^{238}\text{U}(\alpha, 2n)^{240\text{f}}\text{Pu}$ ,  $E_\alpha=25\text{ MeV}$

Measurement of conversion electrons

$$\frac{\hbar^2}{2 \cdot \mathcal{I}} = 3.34 \text{ keV}$$

(axis ratio 2:1)

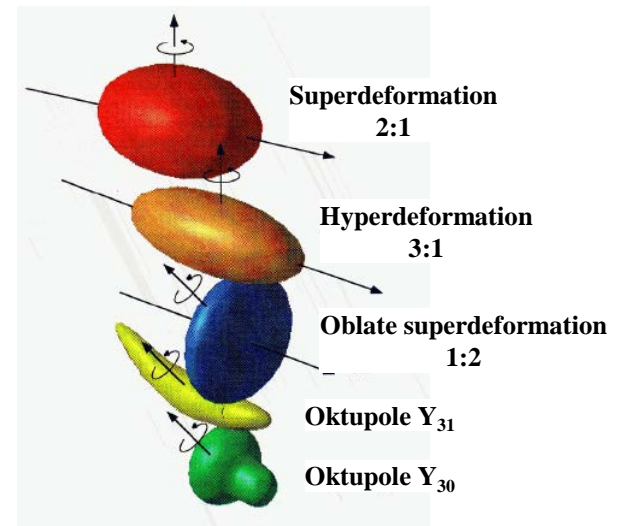

# Induced nuclear fission

Neutrons have not to overcome a Coulomb barrier. Therefore, slow neutrons can also induce nuclear fission.

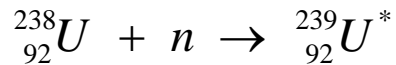

Compound-nucleus: g-u

$$Q_{\text{fission}} = [M({}^{238}\text{U}) + M({}^1_0\text{n}) - M({}^{239}\text{U})] \cdot c^2 = 4.8 \text{ MeV}$$

excitation energy relatively small  $Q_{\text{fission}} < \Delta E_{\text{F}} = 6.4 \text{ MeV}$   
fission is not easily possible

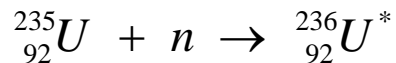

Compound-nucleus: g-g

$$Q_{\text{fission}} = [M({}^{235}\text{U}) + M({}^1_0\text{n}) - M({}^{236}\text{U})] \cdot c^2 = 6.5 \text{ MeV}$$

excitation energy relatively large  $Q_{\text{fission}} > \Delta E_{\text{F}} = 6.1 \text{ MeV}$   
**fission is easily possible**



Abb. 6.15. Schematische Darstellung der durch Neutronen induzierten Kernspaltung

# Characteristic properties of nuclear fission

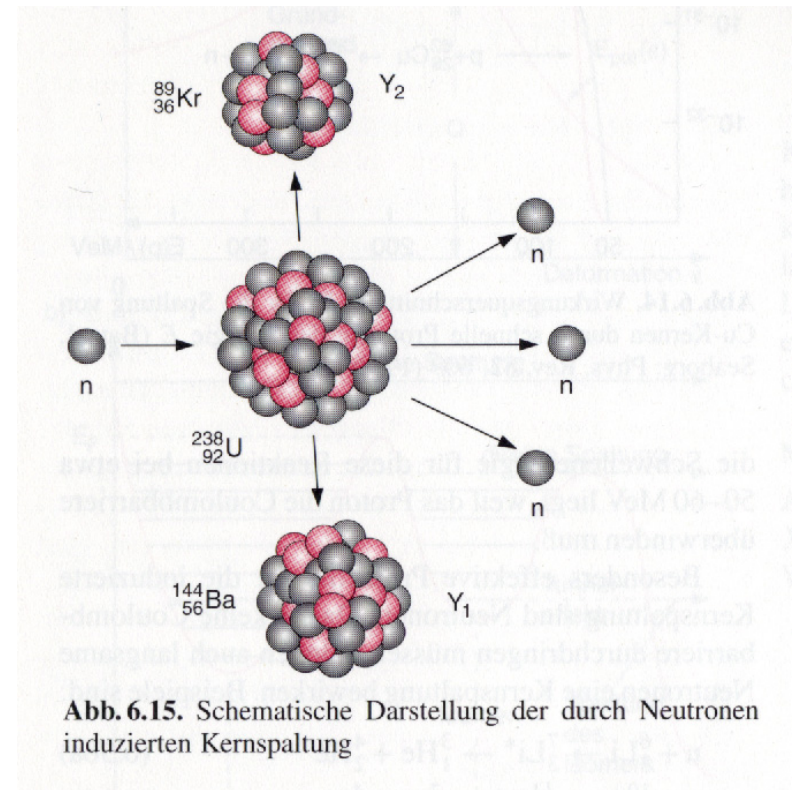
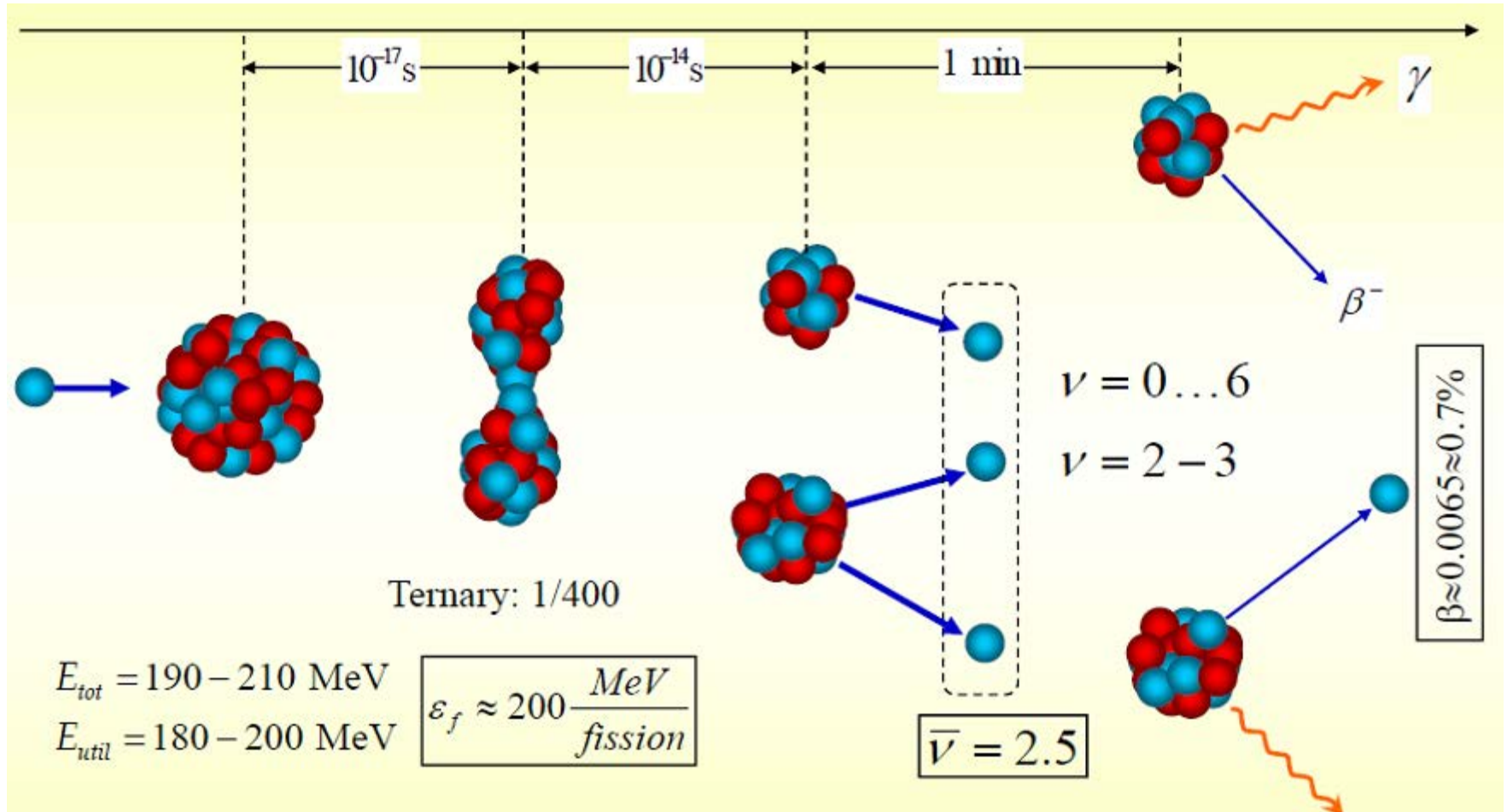

# Characteristic properties of nuclear fission

a) fission **asymmetric**  $\Rightarrow$  multiple **highly excited** daughter nuclei

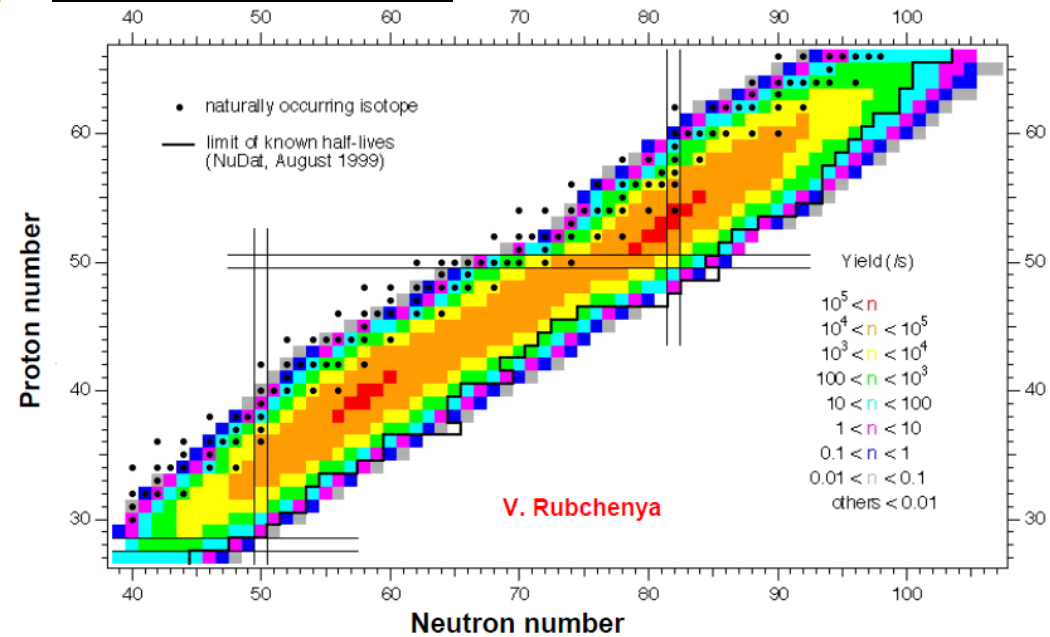
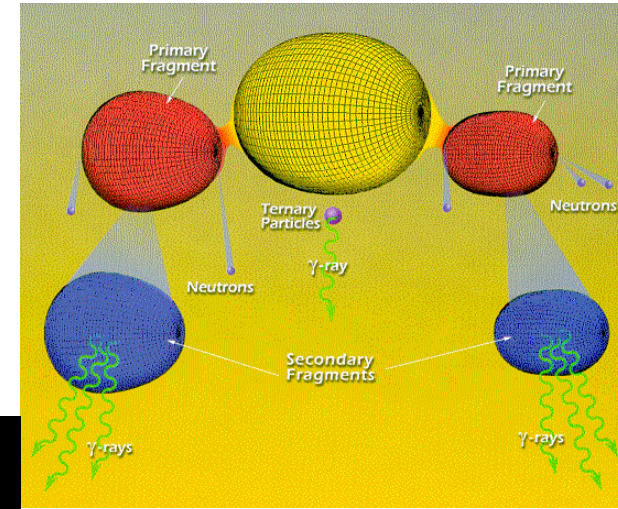
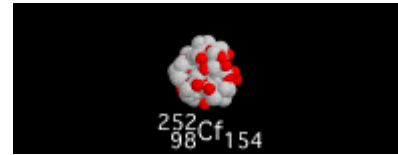
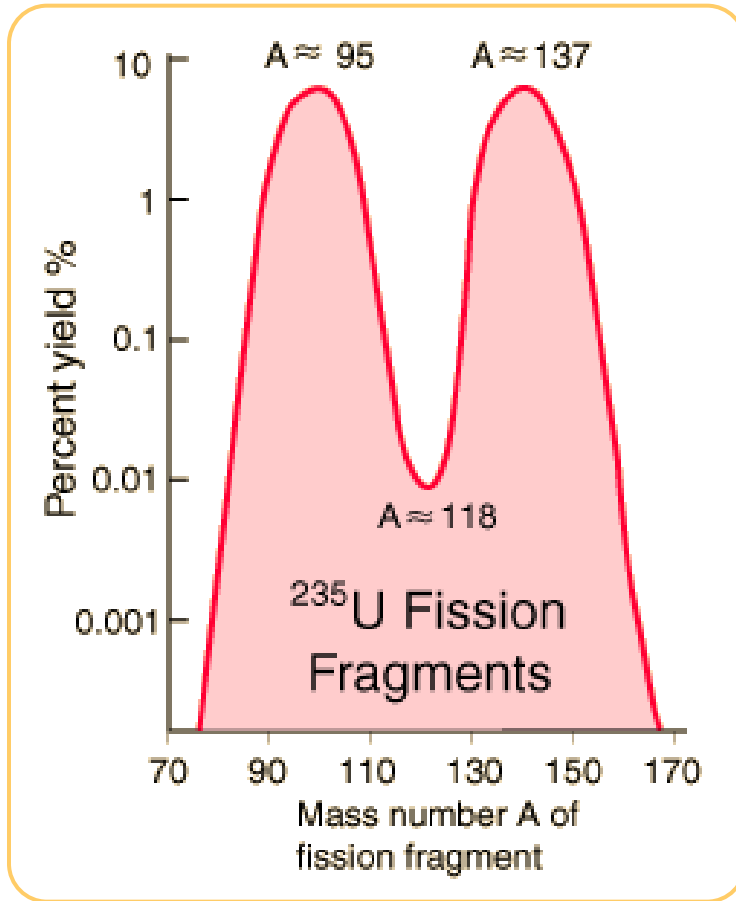



# Characteristic properties of nuclear fission

a) fission **asymmetric**  $\Rightarrow$  multiple **highly excited** daughter nuclei

b) Neutron excess in the daughters:  $\left. \frac{Z}{A} \right|_{\text{U}} < \left. \frac{Z}{A} \right|_{A < 100}$

$\Rightarrow$  many  **$\beta^-$ -instable** daughter nuclei (often long living)

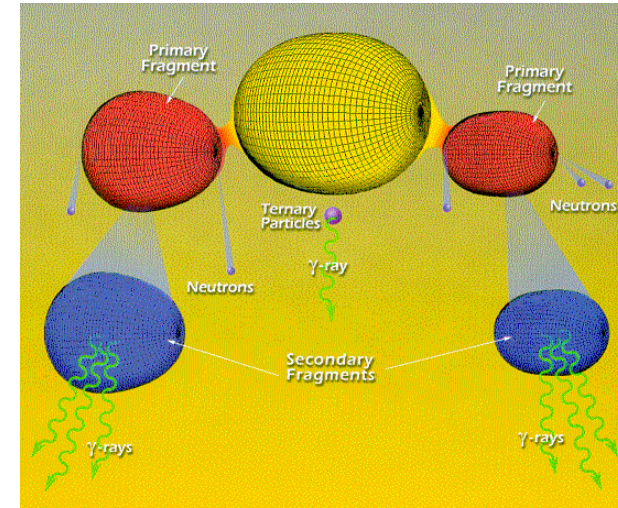

examples:

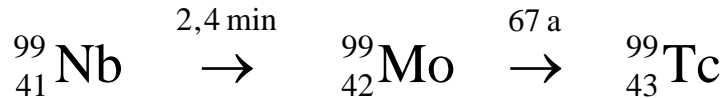
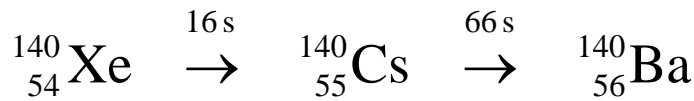

- **$\approx 1000$**  different  **$\beta^-$ -instable** nuclei after
- **long lived  $\beta^-$ -emitter** together with  **${}^{239}\text{Pu}$**

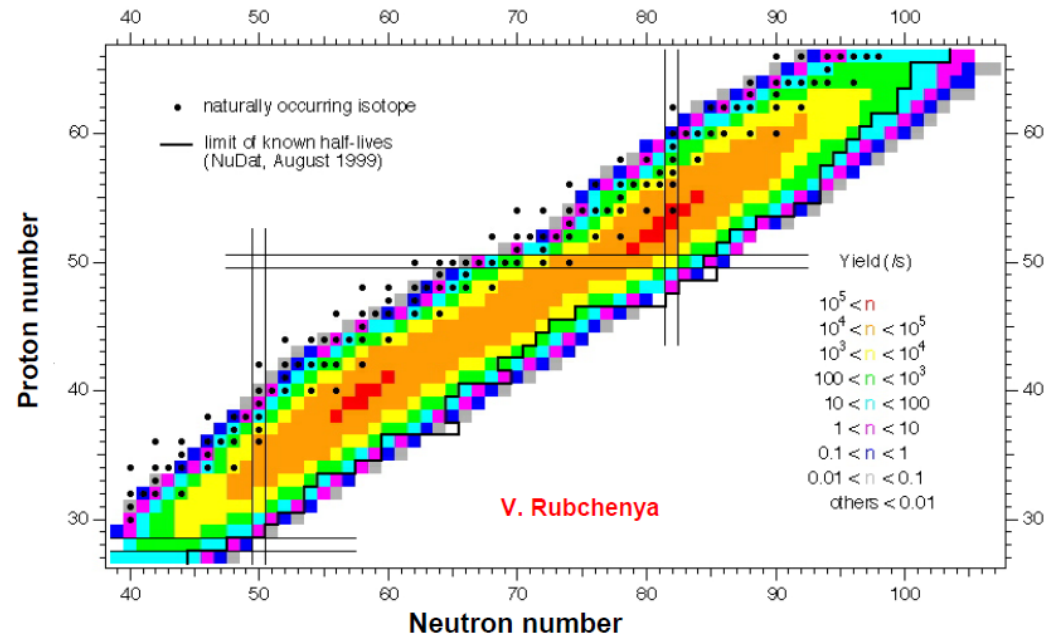



# Characteristic properties of nuclear fission

c) fragments highly excited & neutron excess

⇒ **prompt** ( $\Delta t < 10^{-16}\text{s}$ ) **neutron emission**



neutron-energy spectrum  $\leftrightarrow$   
evaporation from a moving source

Maxwell-Boltzmann distribution

$$k = 8.617 \cdot 10^{-5} \text{ eV}/^\circ\text{K}$$

$$k \cdot T_0 = 0.0253 \text{ eV for } T_0 = 293.61 \text{ }^\circ\text{K}$$

## Important:

Approximately 99% of all neutrons are immediately released

Only 1% are delayed emitted within a time window of  $0.05\text{s} < t < 60\text{s}$

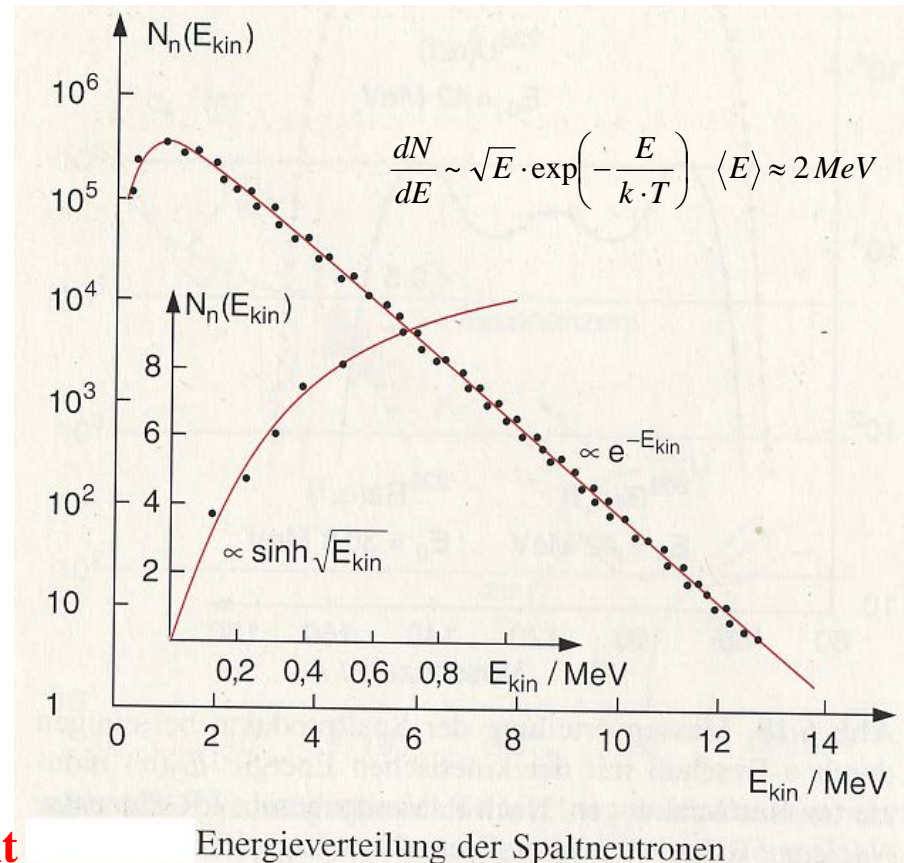

→ **Controlling a nuclear power plant**

# Characteristic properties of nuclear fission

d) **Delayed** neutrons (  $\Delta t = 0,2 \text{ s} \dots 60 \text{ s}$  )



→ ~1% of the neutrons are delayed

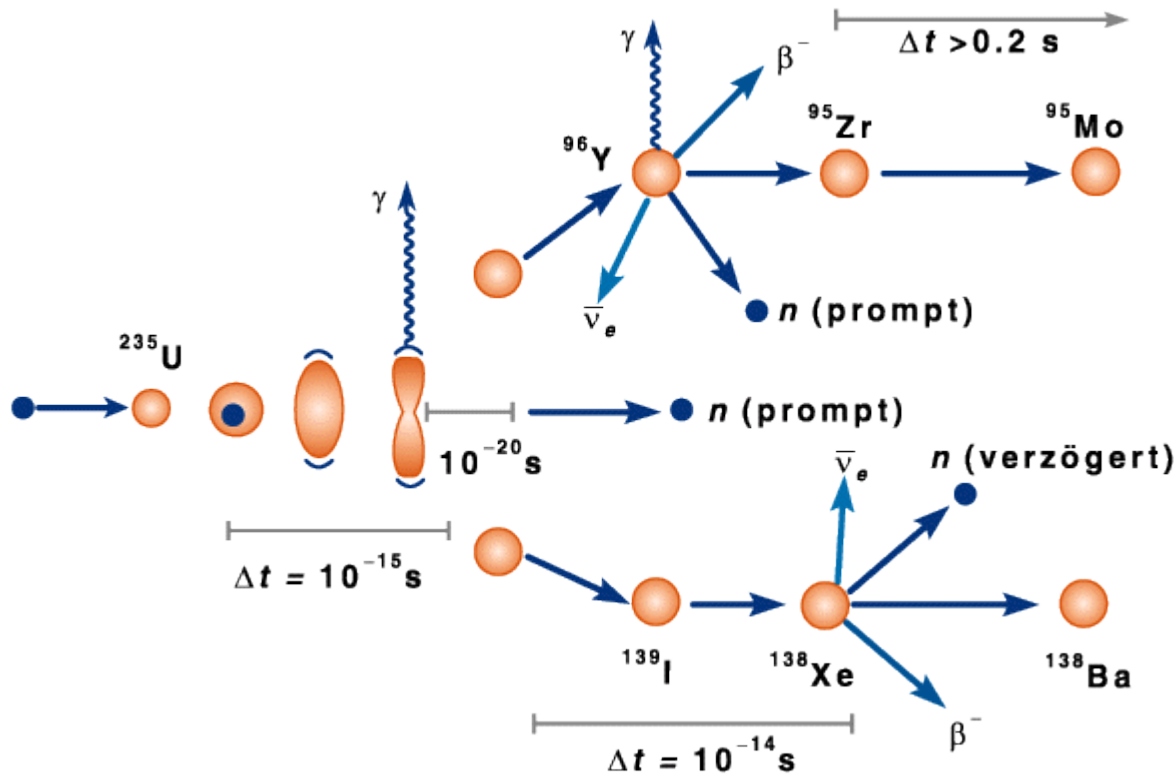

# Characteristic properties of nuclear fission

e) **Energy balance** of the  $^{235}_{92}\text{U}$ -fission

$Y_{\text{small}}$	100 MeV	$\beta^-$ (fission nuclei)	8 MeV
$Y_{\text{large}}$	70 MeV	$\gamma$ (fission nuclei)	7 MeV
$\bar{\nu}_n \cdot n$	5 MeV	neutrinos ( $\bar{\nu}_e$ )	12 MeV
$\gamma$ (prompt)	7 MeV	<b>total:</b>	<b>210 MeV</b>

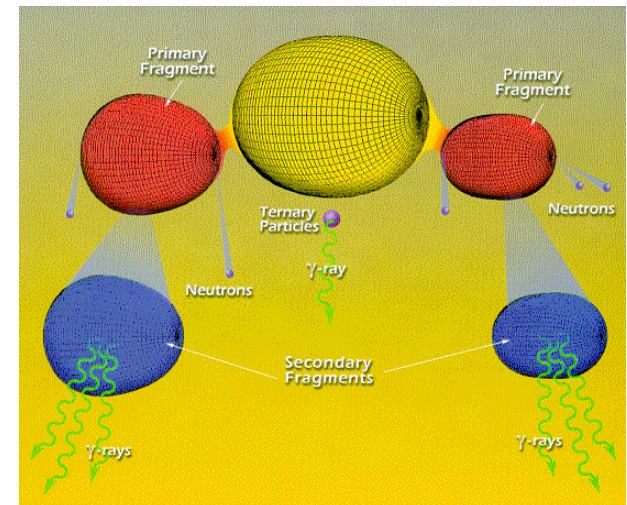

# Absorption- and fission cross sections for neutrons

The neutrons, created during fission, can participate in different reactions and are hence lost for future fission processes.

example:  $(n,\gamma)$  absorption reaction



For  $^{238}\text{U}$  the cross section for inelastic collisions  $\sigma(n,n'\gamma)$  is larger than the fission cross section  $\sigma(n,f)$ . In  $^{238}\text{U}$  a chain reaction can not occur.

A chain reaction can occur only with thermalized neutrons and fission of  $^{235}\text{U}$ :

→ slowing down (moderation) of neutrons.

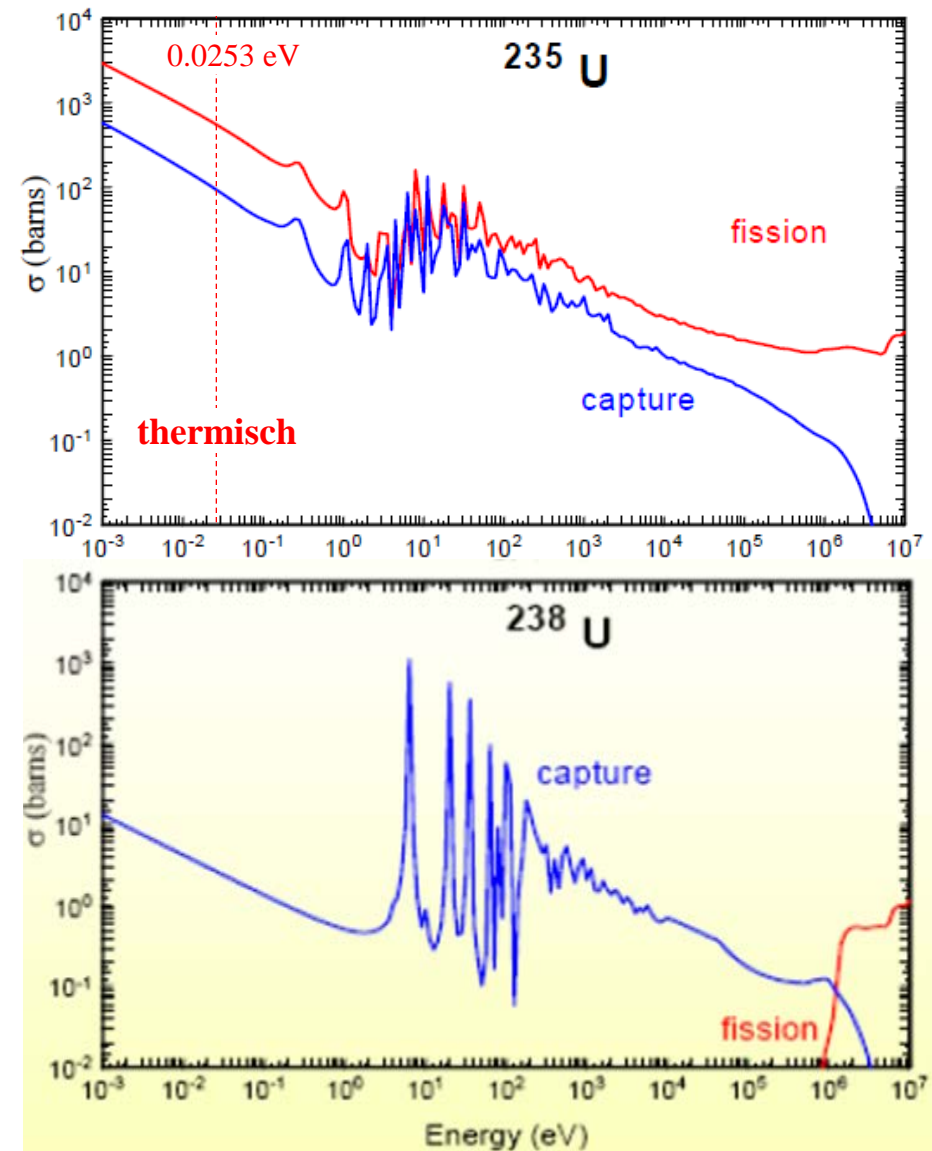

# Absorption- and fission cross sections for neutrons

We start with thermalized neutrons,

$\eta$  is the average number of fission neutrons per thermalized neutron.

$$\eta = \frac{\sigma_{fission}}{\sigma_{fission} + \sigma_{abs}} \cdot \langle v \rangle$$

$$\sigma_{fission} = \frac{0.72}{100} \cdot \sigma_f(^{235}\text{U}) + \frac{99.28}{100} \cdot \sigma_f(^{238}\text{U}) = 4.20 \text{ b}$$

$$\sigma_{capture} = \frac{0.72}{100} \cdot \sigma_a(^{235}\text{U}) + \frac{99.28}{100} \cdot \sigma_a(^{238}\text{U}) = 3.43 \text{ b}$$

For  $^{235}\text{U}$ :  $\sigma_f = 584 \text{ b}$  and  $\sigma_a = 97 \text{ b}$ ,  $\langle v \rangle = 2.4$

For  $^{238}\text{U}$ :  $\sigma_f = 0 \text{ b}$  and  $\sigma_a = 2.1 \text{ b}$

Effective value of  $\eta = 1.3$  for natural Uranium is too small for chain reaction.

→  $^{235}\text{U}$  has to be enriched to 3% ( $\eta=1.8$ )

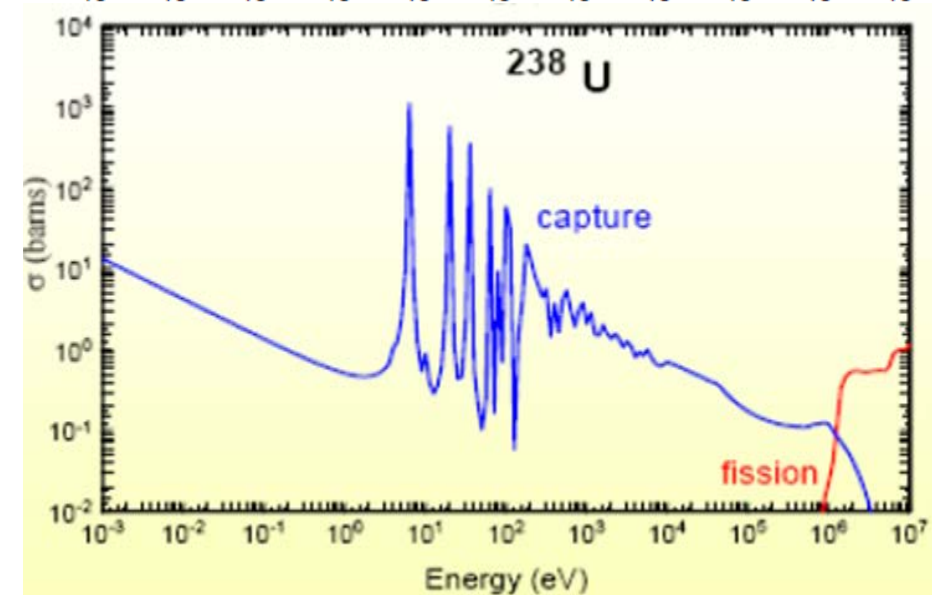
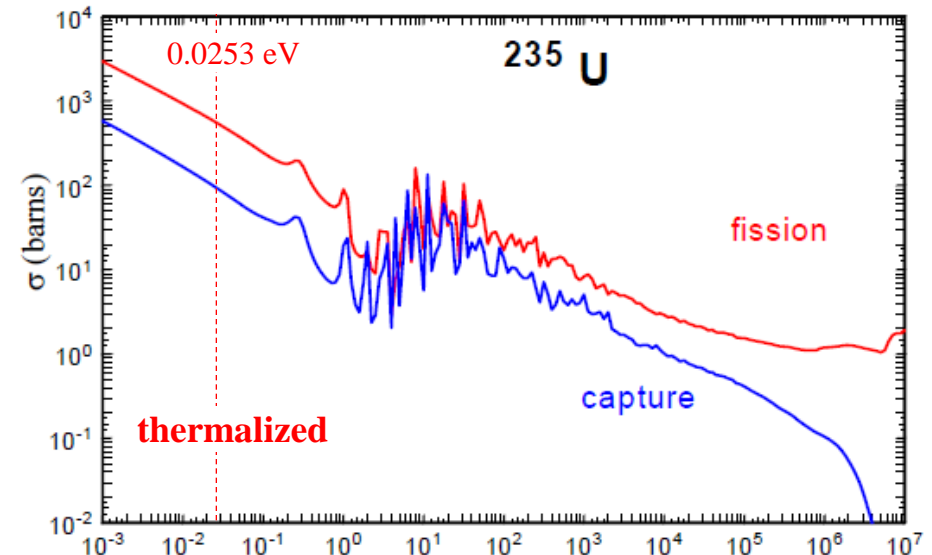



# Interactions of neutrons with matter

Slowing down of neutrons by **elastic** nuclear collisions:

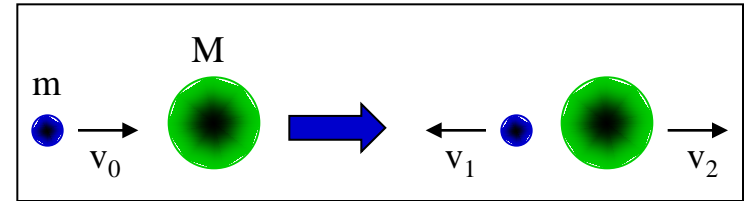
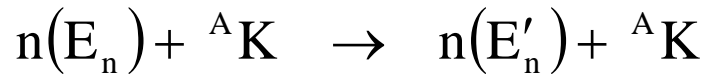

Kinematic of the reaction  $\Rightarrow$

$$\left(\frac{A-1}{A+1}\right)^2 E_n \leq E'_n \leq E_n$$

no excitation, no capture,  
no fission

example:

$A = 1$	$0 \leq E'_n \leq E_n$
$A = 238$	$0,992 E_n \leq E'_n \leq E_n$

Average energy loss of the neutrons per collision:

$$\left\langle \frac{\Delta E_n}{E_n} \right\rangle = 1 - \left\langle \frac{E'_n}{E_n} \right\rangle = \frac{1}{2} \left( 1 - \left( \frac{A-1}{A+1} \right)^2 \right) \Rightarrow \left\langle \frac{\Delta E_n}{E_n} \right\rangle = \frac{2A}{(A+1)^2}$$

# Thermalisation of neutrons

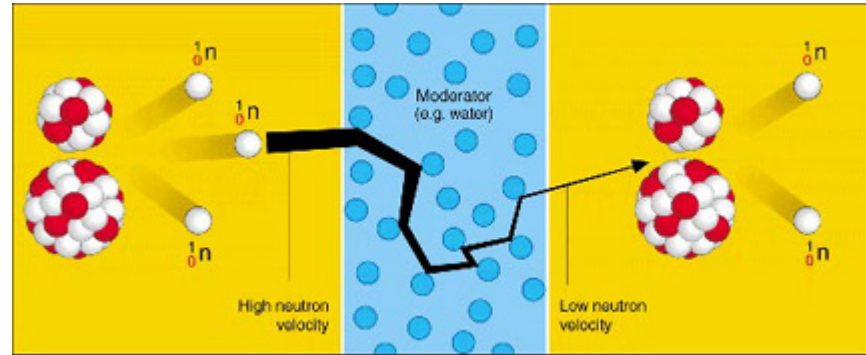

Example: water ( $\text{H}_2\text{O}$ ) as moderator  $\rightarrow$  scattering on protons,  $A = 1$   $\left\langle \frac{\Delta E_n}{E_n} \right\rangle \Big|_{A=1} = 50\%$

Rough estimate of the number of collisions  $k$  until thermalisation:

$$0,5^k \cdot E_n \approx k_B T \approx \frac{1}{40} \text{ eV} \Rightarrow k \approx \frac{1}{\ln 2} \ln \frac{E_n}{k_B T} \quad E_n \approx 1 \text{ MeV} \Rightarrow k \approx 25$$

Moderator	Average collision number for a slowing down from 1,75 MeV to 0.025 eV	Tendency to capture thermalized neutrons in relative units
Hydrogen	18	650
Deuterium	25	1
Beryllium	86	7
Carbon	114	10

# Further neutron losses

- $^{238}\text{U}$ -absorption
- Reactor poison, e.g. the fission product  $^{135}\text{Xe}$ :  $\sigma_f(^{235}\text{U}) \approx 500 \text{ b}$   
 $\sigma_{\text{abs}} \approx 3\,000\,000 \text{ b}$
- Control rod material ( Cd, B )  $\Rightarrow$  controlled neutron-absorption
- Reactor fuel:  $\sigma_{\text{tot}}(^{235}\text{U}) > \sigma_f(^{235}\text{U})$

# Steering of the chain reaction

## ❖ Control rods:

Material with large neutron-absorption: B, Cd, In, Ag

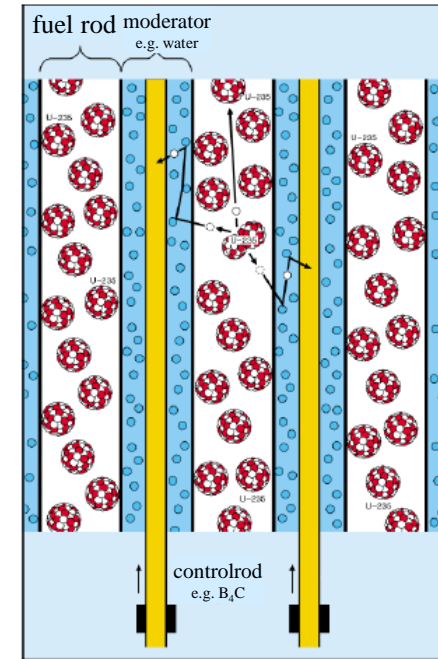
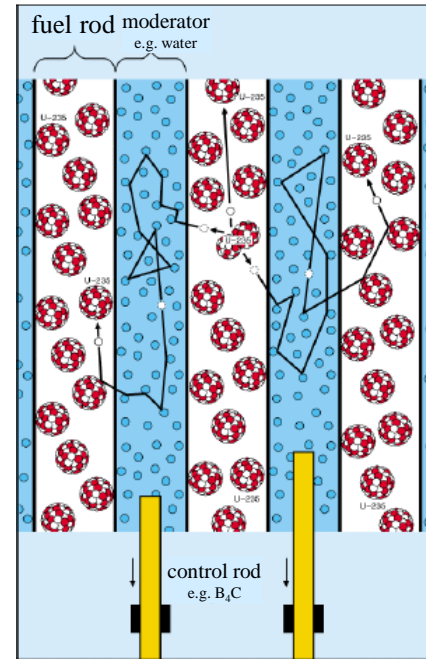
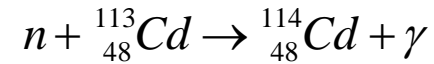
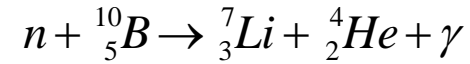
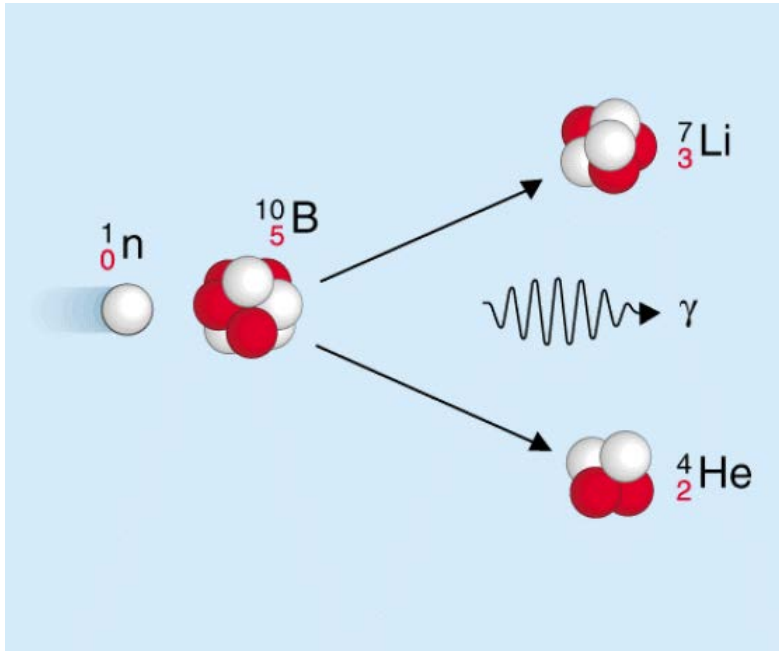

# Energy consumption of humans in Germany

Information in power (Watt) = energy / time (Joule/sec) per head, annual mean

turnover of the body (food → heat) 100 Watt

total consumption on **primary energy** 5000 Watt  
(civilization increases consumption by a factor of 50 !!!)

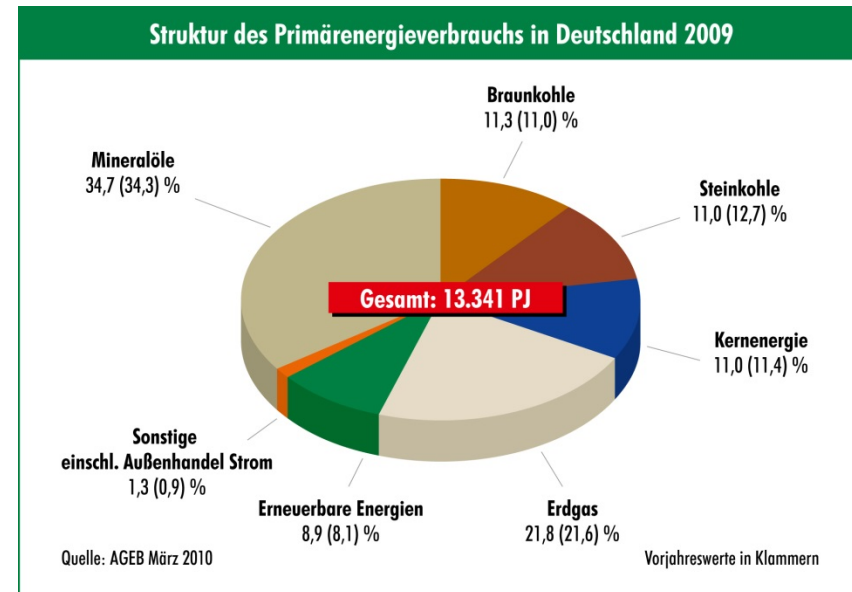

total consumption on **final energy** (2005) 3700 Watt  
electrical power consumption (with industry) 750 Watt  
Private households heating and hot water 1000 Watt



# Chemical energy

Chemical energy is **atomic energy** in the truest sense of the word.

Origin of the chemical energy: Change of the **covalent bonds between atoms** which are the molecular building blocks.

**12g Carbon-burning with 32g Oxygen (O<sub>2</sub>)**

**Thermal energy: 393 kJ ~ 30 kJ/gC**

reaction  $C + O_2 \rightarrow CO_2 + 4.1 \text{ eV}$

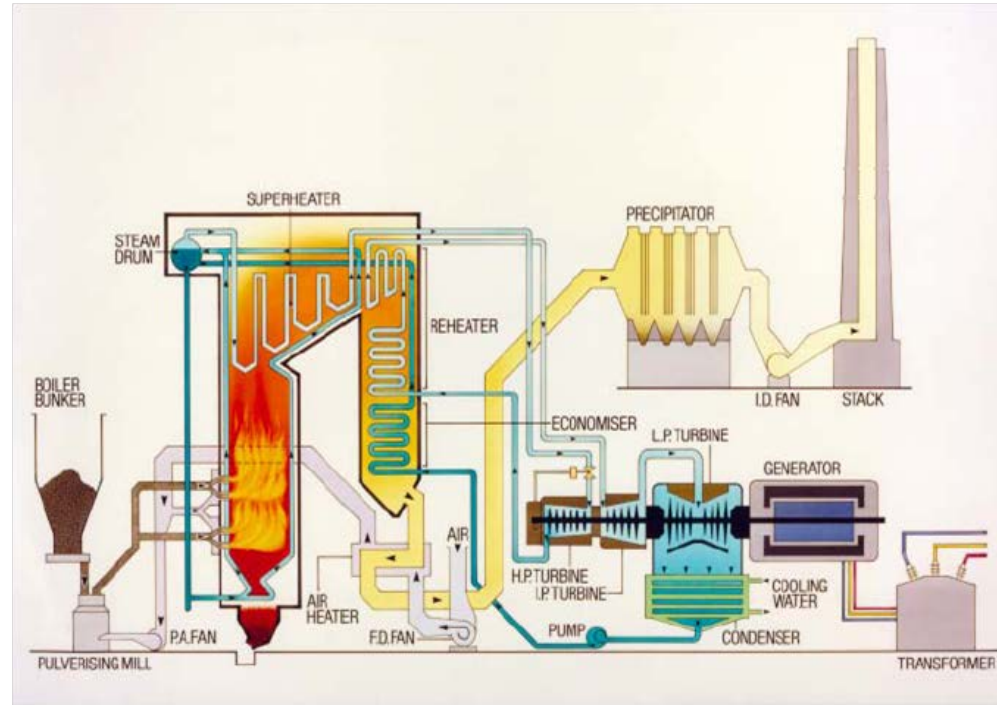

**Thermal energy** ( $Q = m \cdot c \cdot \Delta T$ ,  $c = 4180 \text{ JK}^{-1}\text{kg}^{-1}$ ):  
30 kJ can heat up 1 liter of water by 7<sup>o</sup> Celcius .

**Electrical energy** ( $W = \text{power times time}$ ):  
30 kJ can keep a 100 Watt lamp 5 minutes long switched on.

**Mechanical energy** ( $W = \text{mass} \cdot \text{earth acceleration} \cdot \text{height}$ ):  
30 kJ lift a mass of 70kg 43 meter high.

# Comparison with coal burning

If one burns 1 kg of hard coal one obtains an available energy of 8.14 kWh.



In nuclear fission of 1 kg Uranium one obtains an available energy of 22 700 000 kWh.

**Nuclear bond 200 MeV** is significant stronger than **molecular bond 4.1 eV**.

**Uranium is as „fuel“ three million times more effective than hard coal.**

In fission of 1 kg Uranium we obtain the same energy as if we would burn 2800000 kg of Carbon to 10.2 millions kg of Carbon dioxide!!!



# Nuclear reactor (functional principle)

## Reactor core contains

- **fuel** enriched Uranium with ~3% U-235  
(comparison: enrichment of bomb: 80% U-235)
- **moderator** water under high pressure (150 bar), to **slow down** the neutrons (increase of the fission probability) and for **cooling** (fission energy is turns into kinetic energy of fission products, which heats up the fuel)
- **absorber** movable control rods (B, Cd, Gd) to adjust the absorption of the neutrons, so that  **$k=1$**  (critical) to keep up the chain reaction.

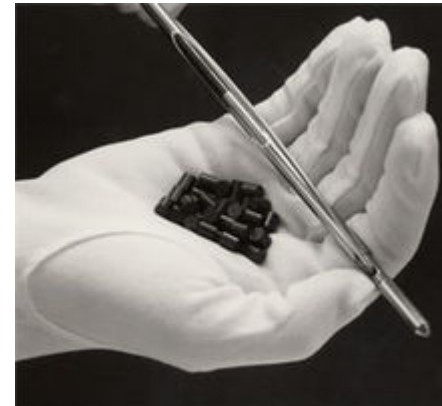
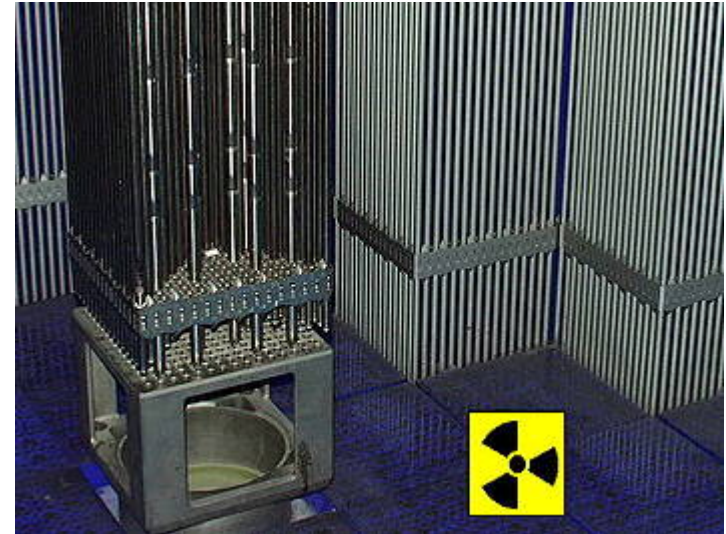

A fuel rod and Uranium-oxide pellets, the fuel of most power reactors.

# From the fuel pellet to the reactor core

**Fuel** in form of **fuel elements**, ~200 of these, each individual water- moderated and cooled. Each element consists of 20-30 **fuel rods**, each fuel rod consists of 200 **Uranium-oxide pellets** size of a pellet: 1 cm in height, 1 cm diameter.

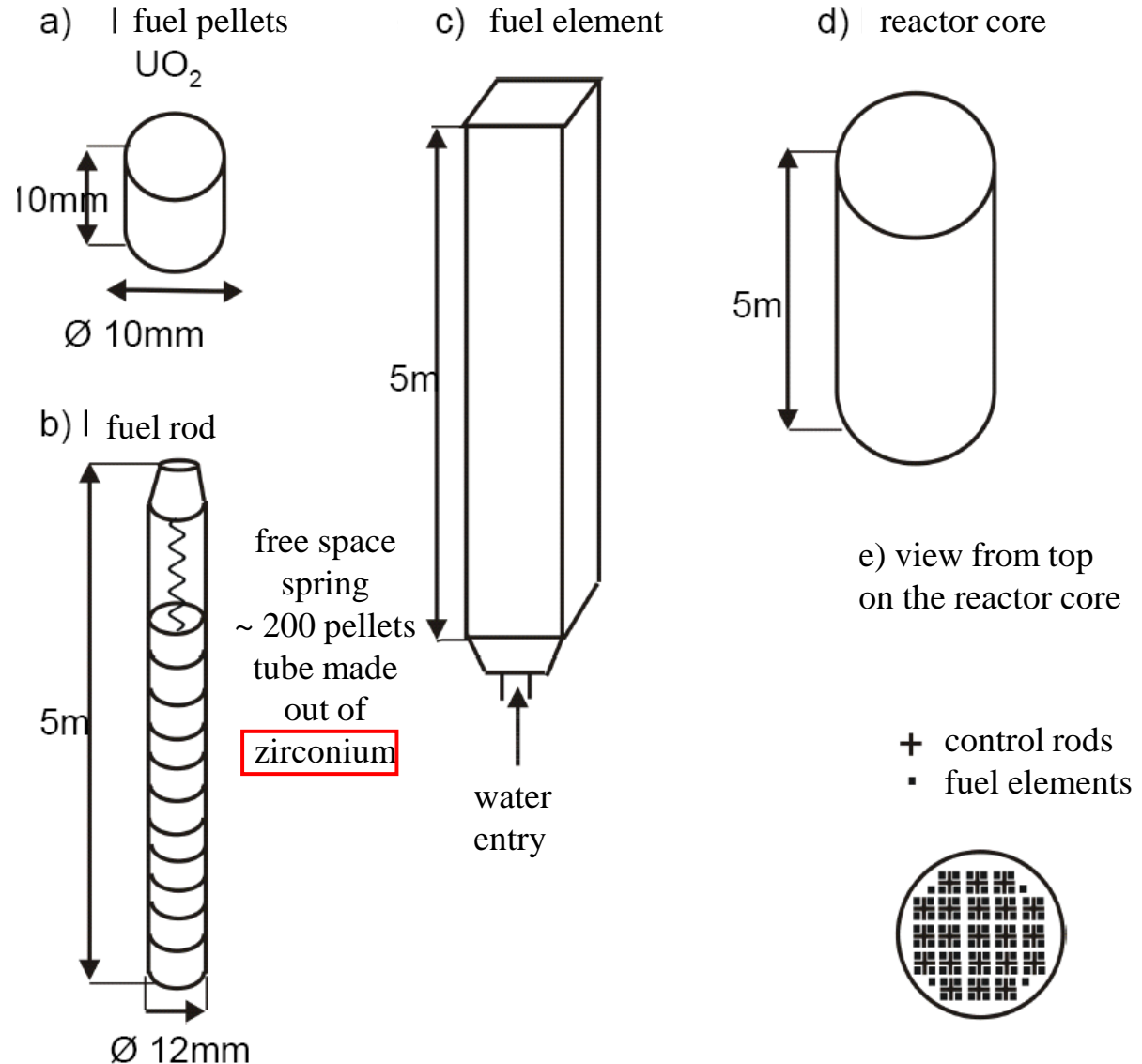



# Neutron balance in a reactor

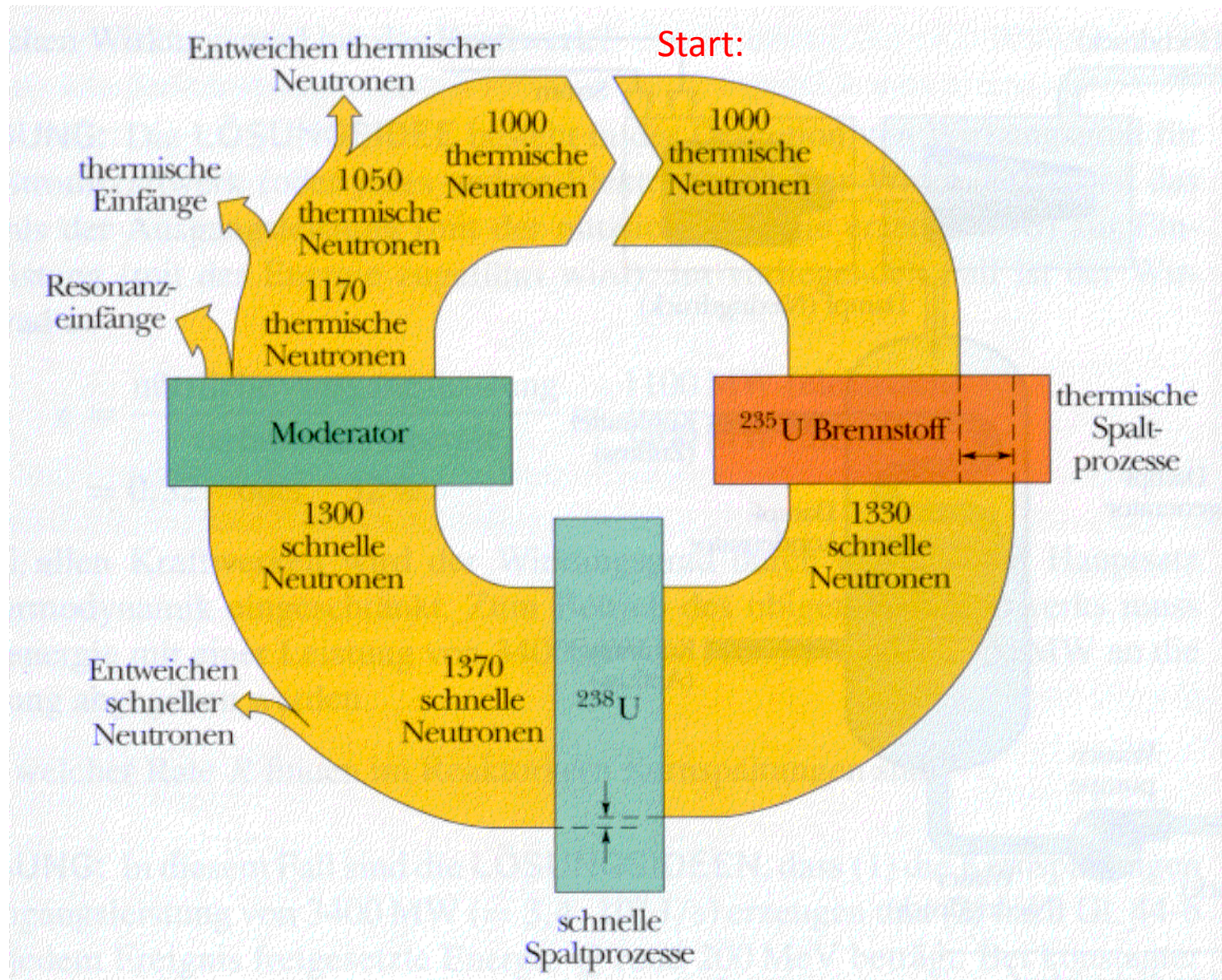

# Reactor dynamics

## neutron lifetime:

- ❖ thermal reactor:  $\sim 20 \mu\text{s}$
- ❖ fast reactor:  $\sim 0.5 \mu\text{s}$

## multiplication factor (reactivity):

$$k_{eff} = \frac{\text{neutron production rate}}{\text{neutron loss rate}}$$

- ❖  $k < 1$  reactor runs down (will be stopped)
- ❖  $k = 1$  constant power
- ❖  $k > 1$  reactor runs up (getting started)

## How is a reactor running a stable mode?

assumption:  $k = 1.001$

- ❖ after 1 s: 50000 generations
- ❖ power multiplication per second:

$$(1.001)^{50000} = 5 \cdot 10^{21}$$

## Why does a reactor not explode?

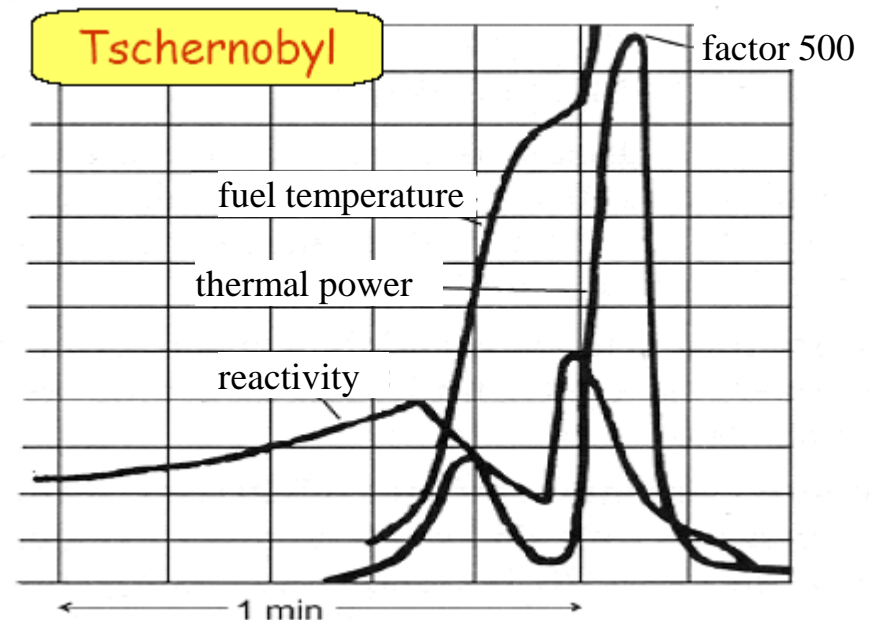



# Reactor dynamics

## How is a reactor running in a stable mode?

0.5% of the neutrons from  $^{235}\text{U}$  are emitted delayed by about 10 s from the fission fragments

- ❖  $k < 1$ : under critical reactor
- ❖  $1 < k < 1 + \beta$ : delayed critical reactor
- ❖  $k > 1 + \beta$ : prompt critical reactor

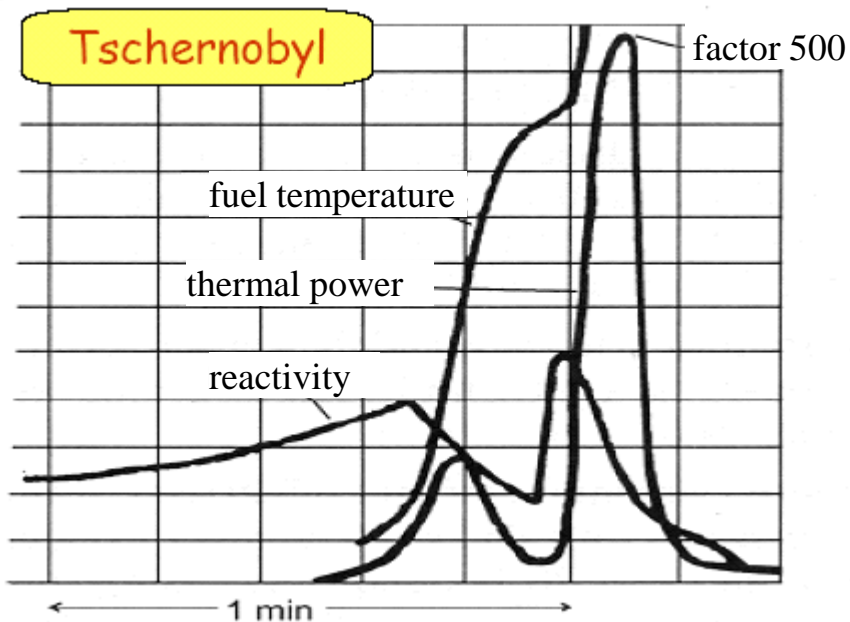

## Examples for the change of reactivity during operation:

- ❖ burn-off of nuclear fuel
- ❖ conversion (“breeding”) due to neutron bombardment

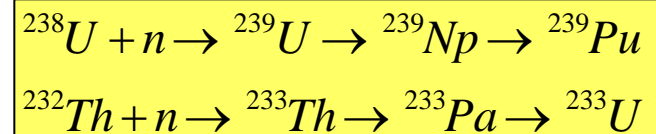

- ❖ decay of fission material
- ❖ adding neutron poisons (e.g. Bor in water, control rods)
- ❖ change in the moderator-fuel ratio
  - density change of water (temperature)
  - bubble formation (pos./ neg. reactivity coefficient)
  - water losses
- ❖ reactivity losses due to Doppler broadening of the reaction cross sections at high temperatures

# Reactor dynamics

Examples for the change of reactivity during operation:

❖ Xenon peak:  $^{135}\text{Xe}$  is a neutron poison

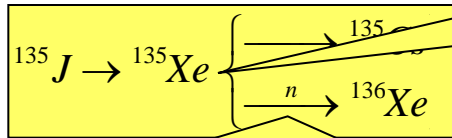

If one reduces the reactor power there will be an excess of  $^{135}\text{Xe}$  (neutron poison), which will reduce the reactivity even more and only after many hours it will vanish.

During operation  $^{135}\text{Xe}$  will be continuously reduced due to neutron bombardment

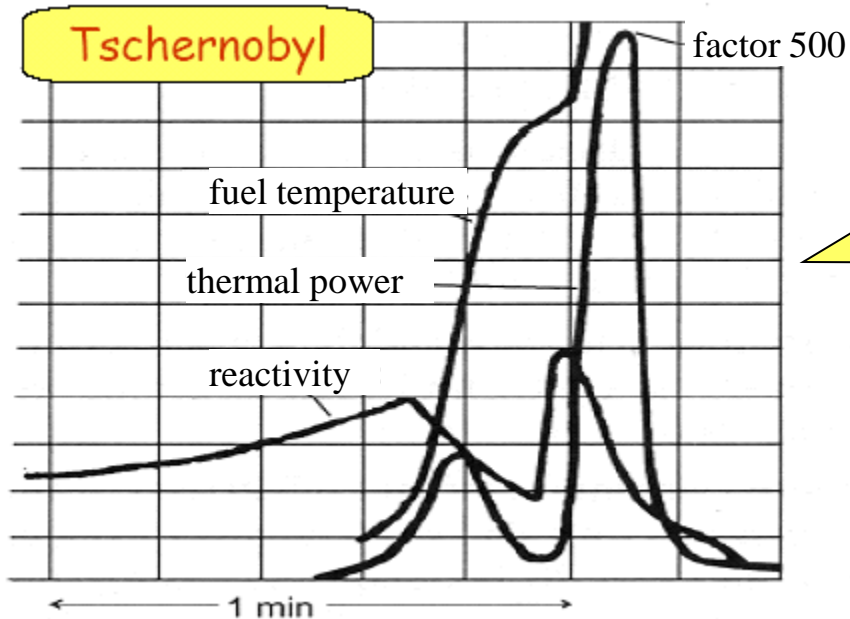

In Tschernobyl all control rods were removed in order to prevent a complete shut-down of the reactor due to the Xe-peak. Then the power increased so fast that the control rods could not be brought back fast enough. The positive bubble coefficient increased the reactivity in addition. First the explosive ejection of fuel made the reactor under-critical.

# Energy transfer in a nuclear reactor

- release of **nuclear binding energy** during fission
- Transfer into kinetic energy of the fission products
- **Thermal energy due to slowing down** of the fragments (neutrons) in the solid fuel
- Use of the thermal energy to heat and **evaporate the cooling medium** (water)
- Water steam will be guided to a **turbine**
- Transformation of the rotational energy of the turbine into **electrical energy via a generator**
- Supply the electricity into the grid
- The waste heat will be given either directly (e.g. into a river) or indirectly (e.g. via a cooling tower to air) to the environment.

# Energy transfer in a hot water reactor

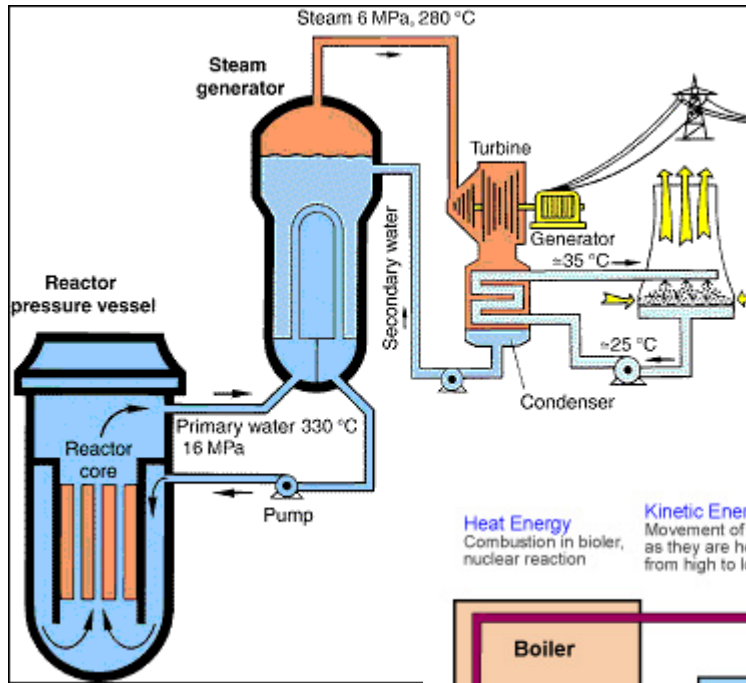

**Heat Energy**  
Combustion in boiler,  
nuclear reaction

**Kinetic Energy**  
Movement of steam molecules  
as they are heated and expand  
from high to low pressure.

**Kinetic Energy**  
Movement of turbine and generator

**Electrical Energy**  
Transferred to grid

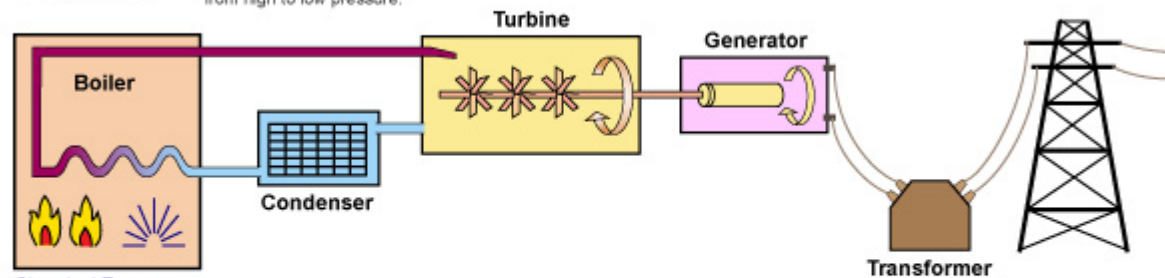

**Chemical Energy**  
Stored in fuel (coal, gas, nuclear)

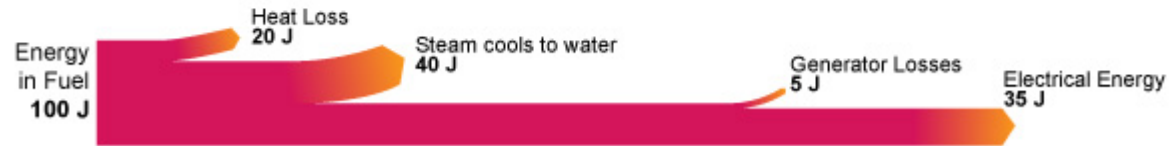

© Pass My Exams

# Energy transfer in a pressure water reactor

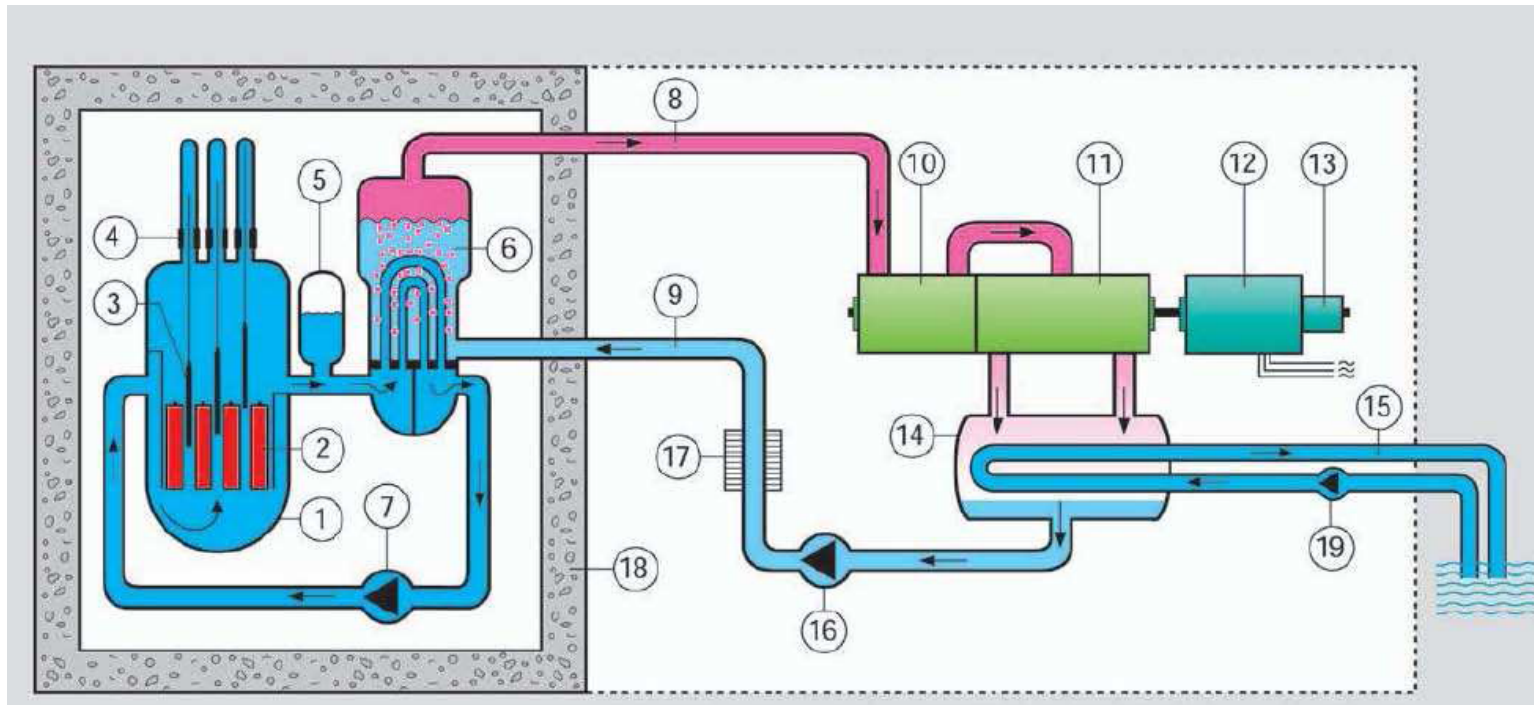

1 Reaktordruckbehälter  
2 Uranbrennelemente  
3 Steuerstäbe  
4 Steuerstabsantriebe  
5 Druckhalter  
6 Dampferzeuger  
7 Kühlmittelpumpe  
8 Frischdampf  
9 Speisewasser

10 Hochdruckteil der Turbine  
11 Niederdruckteil der Turbine  
12 Generator  
13 Erregermaschine  
14 Kondensator  
15 Flußwasser  
16 Speisewasserpumpe  
17 Vorwärmanlage  
18 Betonabschirmung

19 Kühlwasser-  
pumpe

# Light water reactor in Chernobyl

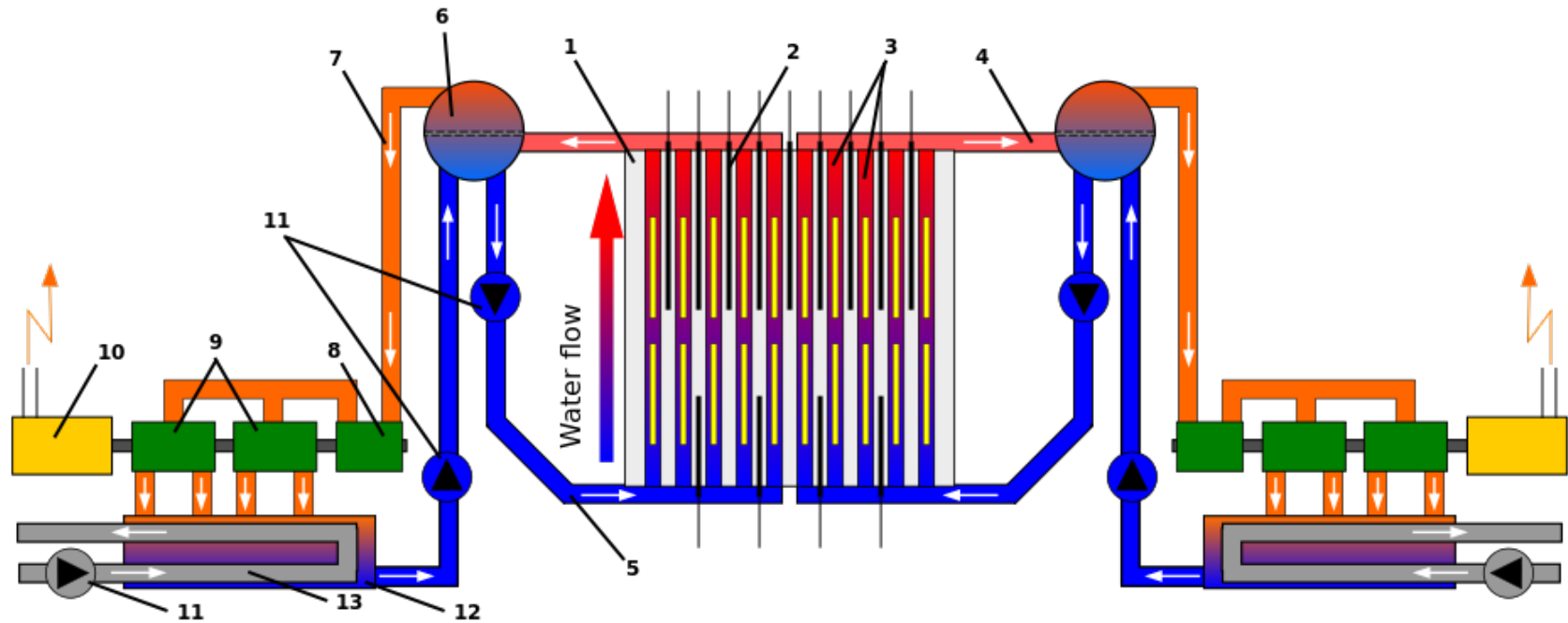

## Legend :

- |                                     |   |
|-------------------------------------|---|
| 1. Graphite moderated reactor core  | 8. High-pressure steam turbine            |
| 2. Control rods                     | 9. Low-pressure steam turbine             |
| 3. Pressure channels with fuel rods | 10. Generator                             |
| 4. Water/steam mixture              | 11. Pump                                  |
| 5. Water                            | 12. Steam condenser                       |
| 6. Water/steam separator            | 13. Cooling water (from river, sea, etc.) |
| 7. Steam inlet                      |   |

Der mit Graphit moderierte Siedewasser-Druckröhrenreaktor von Tschernobyl. (Kann natürliches Uran verwenden)  
Brennelemente hängen in ca. 1660 Druckröhren in senkrechten Bohrungen im Graphit, 210 Steuer- und Absorberstäbe.



# Decay heat

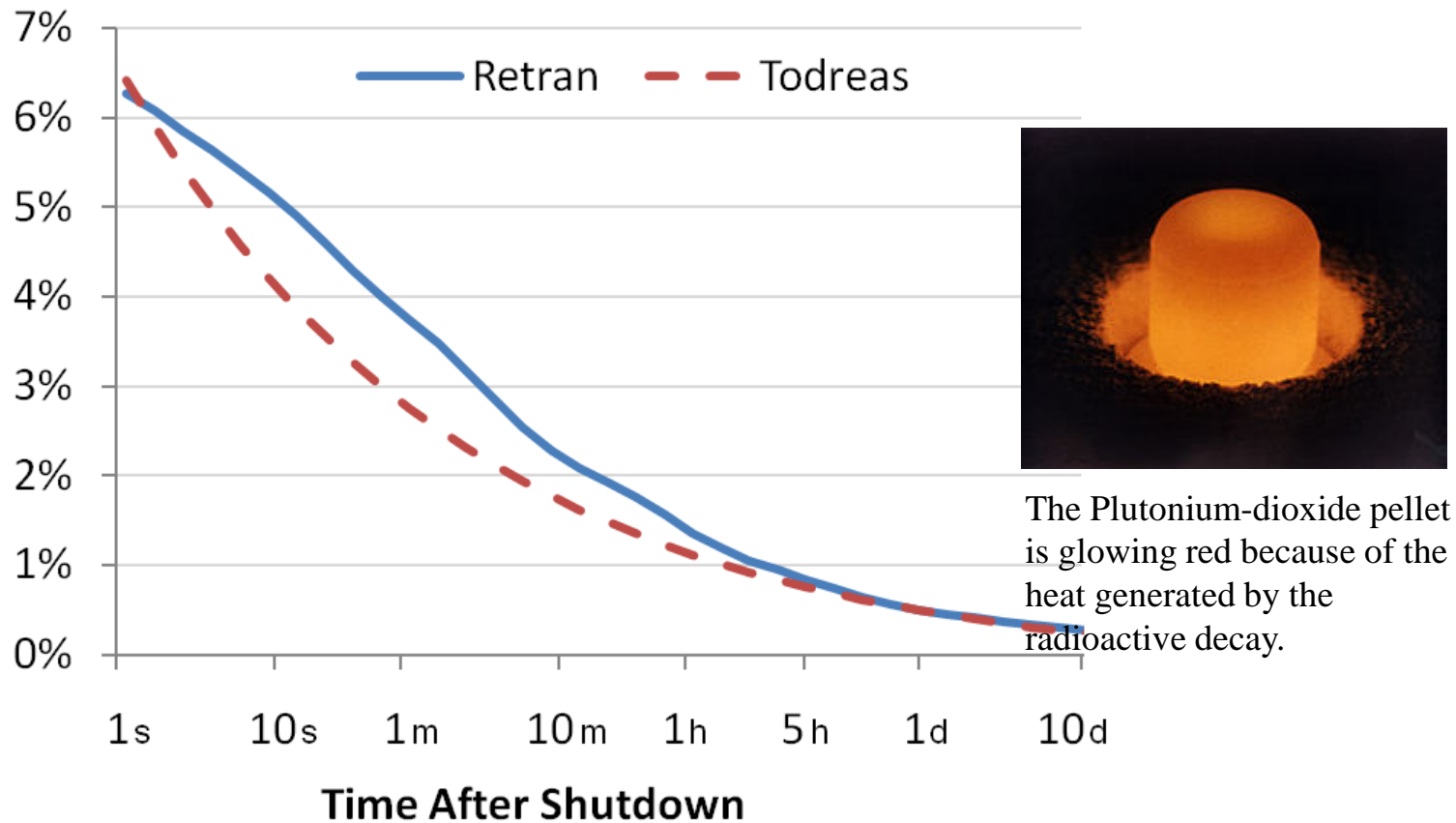

When a nuclear reactor has been shut down and nuclear fission is not occurring at a large scale, the major source of heat production will be due to the delayed beta decay of these fission products (which originated as fission fragments). For this reason, at the moment of reactor shutdown, decay heat will be about 6.5% of the previous core power if the reactor has had a long and steady power history. About 1 hour after shutdown, the decay heat will be about 1.5% of the previous core power. After a day, the decay heat falls to 0.4%, and after a week it will be only 0.2%. ([WIKIPEDIA](#))

# Decay heat after 11 month of operation

If a reactor is operated for the time  $T_0$  [s] with a power of  $P_0$ , then the decay heat power  $P$  at the time  $t$  [s] after the shut-down of the reactor

$$P(t) = P_0 \cdot 6.22 \cdot 10^{-2} \cdot [t^{-0.2} - (T_0 + t)^{-0.2}]$$

<b>Time after shut-down</b>	<b>Decay heat in percent</b>	<b>Thermal power for 4000 MW before shut-down</b>	<b>Time to heat-up 2500 m<sup>3</sup> water from 15 °C to 100 °C</b>
10 Sekunden	3,72 %	149 MW	100 min
1 Minute	2,54 %	102 MW	146 min
1 Stunde	1,01 %	40 MW	6 h
1 Tag	0,44 %	18 MW	14 h
3 Tage	0,31 %	13 MW	20 h
1 Woche	0,23 %	9 MW	26 h
1 Monat	0,13 %	5 MW	49 h
3 Monate	0,07 %	3 MW	89 h

# Storage pool

In case of a leakage or failure of the cooling the water can leak out or evaporate. In this case the stored fuel elements can be excessively heated.

If water is still present in the pool, the Zircaloy of the fuel rods can react with the water steam at  $\sim 800^{\circ}\text{C}$ . In an exothermic redox reaction Zirconium-oxide and Hydrogen is produced which will create an explosive Knallgas mixture in a short time.

In case of no cooling at all the fuel rods can start burning which will destroy the fuel elements.

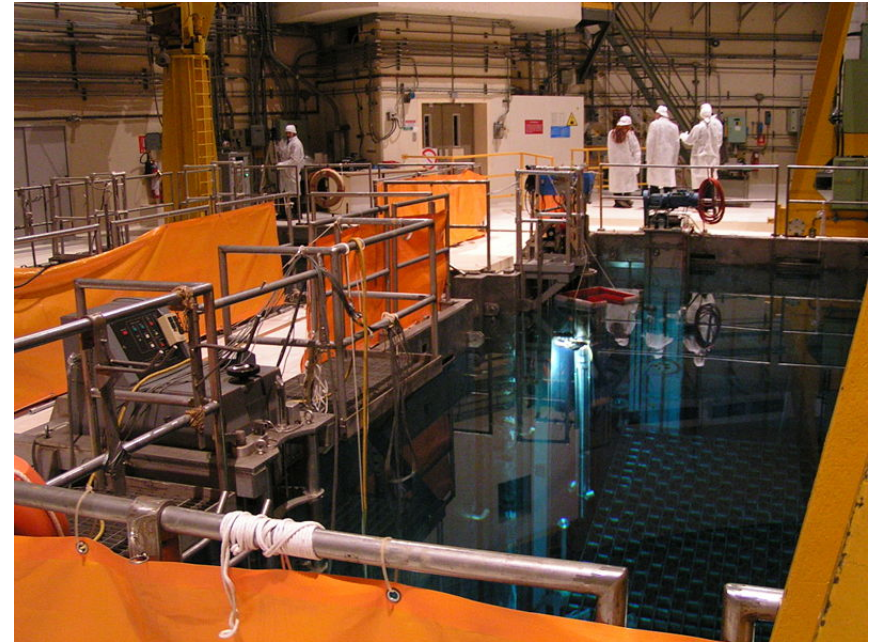

# Welt Kernenergie

- ❖ 443 nuclear reactors in 30 countries (Jan. 2006)
- ❖ ~16% of the world energy production (2003)
- ❖ 24 reactors in construction

